



ANNUAL REPORT
2021

A LEADER IN INTUITIVE MOTION CONTROL

NEXTEER AUTOMOTIVE GROUP LIMITED

耐世特汽車系統集團有限公司

STOCK CODE: 1316

Incorporated under the laws of the Cayman Islands with limited liability

OUR STRATEGY FOR PROFITABLE GROWTH



Expand & Diversify
Revenue Base



Strengthen
Technology Leadership



Capitalise on EPS
as Enabler for ADAS



Optimise
Cost Structure



Pursue Select
Acquisitions & Alliances



Target China &
Emerging Markets

Contents

Corporate Profile	2
Corporate Information	4
Company Overview	6
CEO Statement	7
Our Products & Technologies	11
Business Overview	17
Financial Highlights	38
Management Discussion and Analysis	39
Directors and Senior Management	51
Directors' Report	61
Corporate Governance Report	78
Independent Auditor's Report	90
Consolidated Balance Sheet	96
Consolidated Income Statement	98
Consolidated Statement of Comprehensive Income	99
Consolidated Statement of Changes in Equity	100
Consolidated Statement of Cash Flows	101
Notes to the Consolidated Financial Statements	102
Five Years' Financial Summary	170

Corporate Profile

Nexteer Automotive Group Limited (the **Company**) together with its subsidiaries are collectively referred to as **we, us, our, Nexteer, Nexteer Automotive** or the **Group**. Nexteer Automotive is a global leader in advanced steering and driveline systems, as well as advanced driver assistance systems (**ADAS**) and automated driving (**AD**) enabling technologies. In-house development and full system integration of hardware, software and electronics provides Nexteer a competitive advantage as a full-service supplier to automotive original equipment manufacturers (**OEM**) around the world.

As a leader in intuitive motion control, our continued focus and drive is to leverage our design, development and manufacturing strengths in advanced steering and driveline systems to provide differentiated and value-added solutions to our customers. We develop innovative solutions that enable a new era of safety and performance for all levels of ADAS/AD, as well as supporting all modes of vehicle propulsion, be it traditional internal combustion, hybrid or pure electric systems. Overall, we are making driving safer, greener and more fun for today's world in an increasingly electrified and automated future.

Our ability to seamlessly integrate our systems into OEM vehicles is a testament to our more than 110-year heritage of vehicle integration expertise and product craftsmanship. Our "One Nexteer" culture inspires employees to achieve personal and corporate growth by focusing on our core values across all aspects of the Company: people first, operational excellence and enterprise growth.

We strive to be the partner of choice for our customers and suppliers by delivering highly engineered, safety-critical products and building enduring relationships.

Nexteer provides real-world, vehicle-level solutions by being:

- **Customer Focused:** Respected and trusted for delivering on commitments
- **Proactive:** We listen carefully to understand customer needs, requirements and aspirations
- **Innovative:** A market leader in steering and driveline system innovation and value-added service
- **Agile:** Able to respond quickly with high-quality, cost-effective solutions
- **Global:** Committed to exceeding customer and vehicle needs every time, in every customer-targeted market

GLOBAL HEADQUARTERS



Auburn Hills, MI, USA

TECHNICAL CENTRES



Saginaw, MI, USA



Suzhou, China



Tychy, Poland

GLOBAL FOOTPRINT & CUSTOMERS

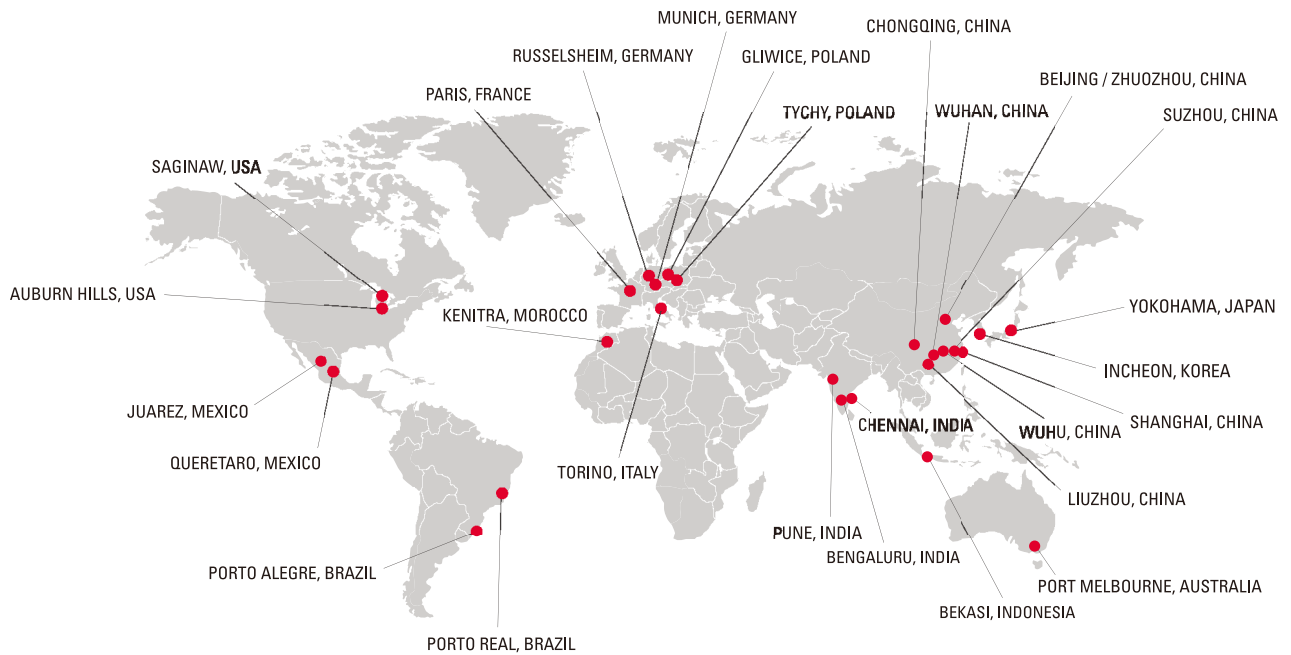

- **World Headquarters:** Auburn Hills, Michigan, United States of America (**USA** or **US**)
- **Manufacturing Plants:** 26, including 2 non-consolidated joint ventures (**JV**)
- **Technical & Software Centres:** 4
- **Customer Service Centres:** 13
- **Global Customers:** 60+, including BMW Group (**BMW**), Changan Automobile Co., Ltd. (**Changan**), Dongfeng Peugeot Citroën Automobile Co., Ltd. (**DPCA**), Ford Motor Company (**Ford**), General Motors Company and Subsidiaries (**GM**), Great Wall Motor Company Limited (**GWM**), Maruti Suzuki India Limited, Renault-Nissan-Mitsubishi Alliance (**RNM**), SAIC General Motors Co., Ltd., SAIC-GM-Wuling Automobile Co., Ltd. (**SGMW**), Stellantis N.V. (**Stellantis**) (formerly Fiat Chrysler Automobiles (**FCA**) and Groupe PSA), Toyota Motor Corporation (**Toyota**) and Volkswagen Group (**VW**) as well as domestic automakers in China, India and South America

Corporate Information

BOARD OF DIRECTORS

Executive Directors

ZHAO, Guibin (趙桂斌)

(Chief Executive Officer and Vice Chairman)

MILAVEC, Robin Zane

FAN, Yi (樊毅)

Non-Executive Directors

WANG, Jian (王堅)

(resigned as Chairman with effect from March 16, 2022)

LIU, Ping (劉平)

(retired with effect from June 8, 2021)

ZHANG, Wendong (張文冬)

LEI, Zili (雷自力) (Chairman)

(appointed as non-Executive Director with effect from June 8, 2021 and as Chairman with effect from March 16, 2022)

Independent Non-Executive Directors

LIU, Jianjun (劉健君)

WEI, Kevin Cheng (蔚成)

YICK, Wing Fat Simon (易永發)

COMPANY SECRETARY

FAN, Yi (樊毅)

AUTHORISED REPRESENTATIVES

ZHAO, Guibin (趙桂斌)

FAN, Yi (樊毅)

LEGAL ADVISERS

As to Hong Kong Law

DLA Piper Hong Kong

As to Cayman Islands Law

Maples and Calder

AUDITOR

Deloitte Touche Tohmatsu

Certified Public Accountants and Registered PIE Auditors

AUDIT AND COMPLIANCE COMMITTEE

WEI, Kevin Cheng (蔚成) (Chairman)

YICK, Wing Fat Simon (易永發)

LIU, Ping (劉平)

(retired with effect from June 8, 2021)

LEI, Zili (雷自力)

(appointed with effect from June 8, 2021 and resigned with effect from March 16, 2022)

WANG, Jian (王堅)

(appointed with effect from March 16, 2022)

REMUNERATION AND NOMINATION COMMITTEE

YICK, Wing Fat Simon (易永發) (Chairman)

LIU, Jianjun (劉健君)

ZHANG, Wendong (張文冬)

HEADQUARTERS

1272 Doris Road

Auburn Hills, Michigan 48326, USA



REGISTERED OFFICE

P.O. Box 309, Ugland House
Grand Cayman, KY1-1104
Cayman Islands

PRINCIPAL PLACE OF BUSINESS IN HONG KONG

31/F, Tower Two
Times Square
1 Matheson Street
Causeway Bay
Hong Kong

PRINCIPAL SHARE REGISTRAR AND TRANSFER OFFICE

Maples Fund Services (Cayman) Limited
P.O. Box 1093, Boundary Hall
Cricket Square
Grand Cayman, KY1-1102
Cayman Islands

HONG KONG BRANCH SHARE REGISTRAR AND TRANSFER OFFICE

Computershare Hong Kong Investor Services Limited
Shops 1712-1716
17th Floor Hopewell Centre
183 Queen's Road East
Wanchai
Hong Kong

PRINCIPAL BANKERS

Bank of America Merrill Lynch
Bank of China
Bank Pekao SA
China CITIC Bank
China Construction Bank
Comerica Bank
JPMorgan Chase & Co.
PKO Bank Polski
Shanghai Pudong Development Bank
Wells Fargo Capital Finance

STOCK CODE

Share Listing
Ordinary Shares
The Stock Exchange of Hong Kong Limited
(Stock code: 1316)

COMPANY WEBSITE

<http://www.nextteer.com/>



COMPANY OVERVIEW

Locations on
6 continents



60+ CUSTOMERS
GLOBALLY

~12,000
Employees

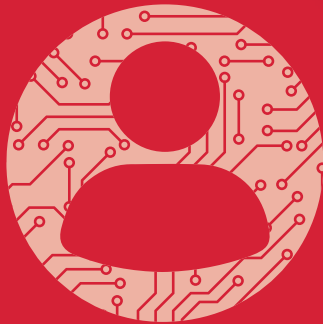

56% of
SALARIED EMPLOYEES
in **TECHNICAL**
ROLES*

US\$ **3.4B**
REVENUE



US\$ **26.8B**
BACKLOG

4 TECH &
SOFTWARE
CENTRES



4 PRODUCT
LINES

- ELECTRIC POWER STEERING
- COLUMNS & INTERMEDIATE SHAFTS
- DRIVELINE SYSTEMS
- HYDRAULIC POWER STEERING

* In 2021, 56% of Nexteer's total salaried workforce was committed to Engineering activities.

CEO Statement



In 2021, we remained committed to our strategy for profitable growth and continued expanding and diversifying our revenue base.

We had a strong year of customer Bookings with notable successes – including breakthrough steering wins with a Japanese OEM, a segment leader in the utility and all-terrain vehicle field, a major global EV leader and multiple NEV start-ups in China.

In early 2022, we expanded our product offering to eDrive and a software solution for road surface detection and vehicle health management.

ZHAO, Guibin
Chief Executive Officer

Dear Shareholders:

On behalf of Nexteer, I am honoured to share with you our 2021 Annual Report and provide an overview of Nexteer's business, near-term operating environment and highlight a few of the year's successes in driving shareholder value.

NAVIGATED THE CHALLENGING, NEAR-TERM ENVIRONMENT

This past year proved to be another challenging period for the automotive industry as we managed the global semiconductor supply shortage, commodity inflation and logistics challenges, all largely a result of the past and continuing effects of the COVID-19 pandemic. The elevated cost environment and the impact of volatile customer vehicle production shifts resulting from constraints across the automotive supply chain proved to be a headwind to our 2021 financial results. Nexteer proactively and diligently worked with both our customers and supplier partners to minimise the impact of supply shortages by leveraging component substitutions, alternative supply arrangements, throughput improvements and other levers within our control.

Working together across our global operating network, our sales, engineering, manufacturing, and supply chain professionals worked tirelessly to find the best possible outcome for all our customers to ensure the best flow of supply to meet their production demand. These efforts stand as a testament to our people who continuously strive to make "tomorrow better than today", no matter the challenges confronted.

Our global team's efforts caught the attention of our customers and the industry – earning Nexteer a list of awards recognising our achievements in supplier partnership, quality, manufacturing, sustainability, employer-of-choice and innovation. I am particularly proud of our team's relentlessly innovative culture that led to three prestigious awards including:

- 2021 *Automotive News* PACEpilot Innovation to Watch for Steer-by-Wire with Stowable Steering Column & CNXMotion Brake-to-Steer
- 2022 CES Innovation Award Honouree for Steer-by-Wire with Stowable Steering Column & Automated Steering Actuator

CEO Statement

As our people and culture are our top priorities, we continued our diligence in ensuring the health and safety of our people during this period, utilising and adjusting our safe work operating protocols to address the changing environments encountered in every region we operate in as we, and all industry participants, faced the many twists and turns of the health crisis as the year progressed. I, and the senior leadership team, remain grateful for the resiliency, creativity and energy of our worldwide team in moving through this current chapter of our journey to be “A Leader in Intuitive Motion Control”, while keeping the well-being of all of our employees and our collaborative, innovative culture as top priorities.

While we will encounter new challenges in 2022 – some expected and others not – I remain confident in the collective capabilities and resourcefulness of our global Nexteer team to quickly adapt and adjust to the external operating environment we are provided, while not losing sight of the long-term tenets of our Strategy for Profitable Growth.

CONTINUED GROWTH PATH: 2021 HIGHLIGHTS

While the operating environment in 2021 was quite challenged, we remain optimistic and confident as industry macro fundamentals remain robust including strong consumer demand, historically low vehicle inventories and continued economic recovery. Further, the pipeline of product technologies and capabilities resulting from Nexteer’s relentless innovation, fully support and enable the significant transformation of mobility that is underway, and specifically, provide real-time solutions to our customers’ vehicle platform needs in the near-term.

Our optimism is bolstered by this past year’s successes in expanding and diversifying Nexteer’s reach across OEM customers, regions, technologies and capitalising on key megatrends such as electrification and software. Following are a few highlights of our 2021 accomplishments that we believe lay the groundwork for our future growth.

- **Successfully launched 36 new customer programmes** across all product lines and regions – marking another year of strong programme launches. Of these customer programmes, 32 represented conquest business and 15 represented EV launches
- **Customer Bookings totaled US\$5.9 billion**, of which 28% represented conquests from competitors, including breakthrough steering wins with a:
 - o Japanese OEM;
 - o Segment leader in the utility and all-terrain vehicle field;
 - o Global EV leader; and
 - o Multiple NEV start-ups in China
- **Recorded Order-to-Delivery Backlog** of Booked Business of US\$26.8 billion – a new record for Nexteer – of which 25% supports EV programmes
- **Leveraged our deep technical competencies** in developing innovative, industry-leading technologies to drive future growth including first to market innovations such as High-Output REPS and Stowable Steering Column
- **Continued commitment to technology leadership and megatrend alignment** for future growth – including electrification and software megatrends

STRONG YEAR OF BOOKINGS & BREAKTHROUGHS

We had a strong year of customer Bookings and accomplished several notable successes even though supply chain constraints delayed some customers' programme nomination processes. Additionally, our mix of Bookings is yet another proof point of Nexteer's continued growth expansion and diversification.

Our Booking success also represents breakthrough steering wins. During the year, Nexteer secured our first REPS conquest Booking with a Japanese OEM. This award further strengthens our global market leadership for REPS broadly, and specifically opens opportunities for cross-selling our other product line offerings to this Japanese OEM. Nexteer also secured our incumbent position on a high-volume North America programme for REPS. We broke into the adjacent market with a powersports vehicle – winning our first EPS programme with the segment leader in the utility and all-terrain vehicle field, and we achieved significant progress with a major global EV leader and booked our first steering business with them. We further strengthened our position in China's NEV market by winning business with multiple NEV start-ups, plus making significant progress in pursuing programmes with additional NEV leaders in the region. We are focused on gaining traction with strategically selected NEV players in China as some will likely play a dominant role in this segment.

Continuing our momentum from 2021, we announced in early 2022 a new eDrive product line with the launch of a 48-volt Integrated Belt-Driven Starter Generator (iBSG) that hybridises conventional internal combustion engine (ICE) vehicles. Nexteer's innovative, cost-effective approach leverages our expertise in steering and driveline and helps OEMs meet emissions regulations while enhancing driving comfort for end consumers.

Also in early 2022, we jointly announced with Tactile Mobility a software solution to improve overall vehicle health management, safety and performance by detecting changing road surfaces (wet, dry, icy, etc.) and evolving tire conditions (tire stiffness, tread depth, etc.). This solution is part of the vehicle's steering system and will enhance the connection among driver, vehicle and road through new, advanced road and tire detection software.

REVIEW OF RESULTS

For the year ended December 31, 2021, the Company's revenue was US\$3,358.7 million which represents a 10.8% increase when compared with 2020. Adjusting for foreign currency and commodity recoveries from our customers, Nexteer's revenue increased by 7.2%, outperforming the increase in global OEM vehicle production of 2.5%, by 470 basis points. Operating profit was US\$115.2 million and net profit attributable to equity holders of the Company was US\$118.4 million.

Nexteer's revenue growth for the full year 2021 continued to outpace the market as measured by the change in global OEM unit production, a result of our continued focus on expanding our regional and product line positions with current customers and securing conquest business with new customers. On the earnings front, although our performance in 2021 was significantly impacted by the various cost headwinds and operating challenges experienced across the broader automotive supply chain, our 2021 net profit attributable to equity holders was 1.4% higher when compared with 2020.

CEO Statement

A SEASON OF REINVENTION & APPRECIATION

2021 was another unique and challenging time and the dedication and resilience of our One Nexteer team moved us through the headwinds and enabled us to capitalise on immediate and longer-term opportunities.

As we look to the future, the mobility industry is embarking upon a season of great reinvention, the likes of which have not been seen in the past 100 years. The pace and scope of change poses exciting opportunities for Nexteer and I am confident that we are well positioned to realise our full growth potential.

To that end, we appreciate the support of our shareholders and the efforts of our One Nexteer team as we anticipate, adapt and seize growth opportunities to strengthen our market leadership and drive increasing shareholder value.

ZHAO, Guibin

Chief Executive Officer

Our Products & Technologies

We design, develop, manufacture and distribute steering and driveline systems and components, primarily for automotive OEMs.

A steering system provides lateral directional control of the vehicle. Our steering system product lines include electric power steering and hydraulic power steering, as well as steering columns and intermediate shafts.

A driveline system transfers power from the gearbox to the driven wheels. Our DL products include front-wheel drive halfshafts, intermediate drive shafts and rear-wheel drive halfshafts, as well as propeller shaft constant velocity (CV) joints.

ELECTRIC POWER STEERING (EPS)

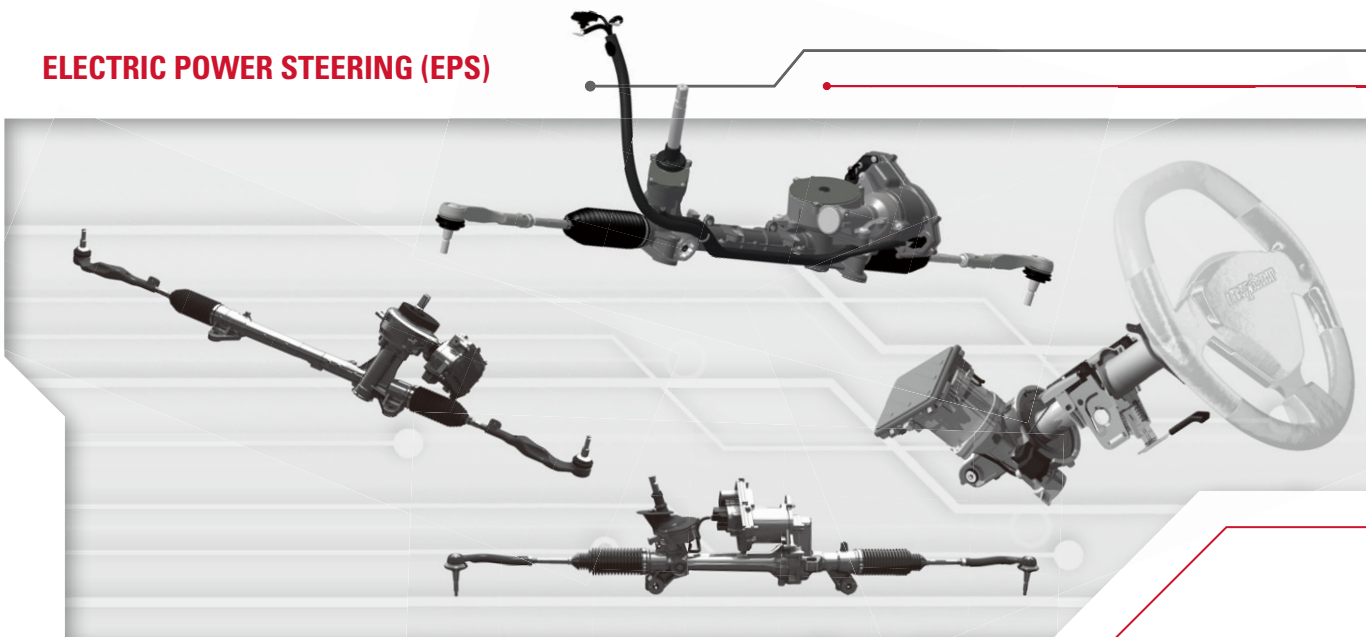

EPS uses an electric motor to assist driver steering. Hardware and software are developed concurrently and work seamlessly together to connect the driver with the road – accounting for driving dynamics and the operating environment. This “connection to the road” provides the driver an experience consistent with the vehicle’s brand (such as luxury, sport, etc.), while also giving important safety cues regarding the type of road surface the driver is traveling on (such as icy, gravel, etc.).

In addition, EPS is a key ADAS feature enabler. EPS translates data from the vehicle’s electronic control unit (ECU) into precise mechanical steering functions. Many Nexteer EPS-enabled ADAS features are already on the road today such as park assist, lane keeping, lane departure warning, traffic jam assist and more.

Depending on the type of EPS system, a computer module applies assistive power via an electric motor coupled directly to either the steering gear or the steering column.

Rack-assist EPS (**REPS**) integrates the required electric assist mechanism with the steering rack where they are contained under the hood in the engine compartment. We have a REPS market-leading position in North America with OEM customers such as: Ford on the F-150 pickup truck; Stellantis (previously FCA) on the Ram 1500 pickup truck; and GM on various light-duty trucks and sport utility vehicles (**SUVs**). We also supply our REPS on performance vehicles, including the Ford Mustang, Dodge Charger and Dodge Challenger.

A first-to-market innovation, Nexteer’s High-Output REPS (**HO REPS**) allows heavier vehicles to take advantage of EPS’s advanced safety, comfort and fuel economy benefits without compromising the vehicle brand’s steering feel. HO REPS also provides the opportunity for a new conversion wave of hydraulic-to-electric power steering for heavy-duty trucks and light commercial vehicles. Three electric vehicle (**EV**) applications showcase our HO REPS, including the GMC Hummer EV, an autonomous Level 4 people mover (with no steering wheel), and an electric light commercial vehicle (delivery van).

Our Products & Technologies

Single pinion-assist EPS (**SPEPS**) integrates the electric assist mechanism with the steering gear pinion shaft. OEM customers who use our SPEPS include: BMW on the 1 Series, 2 Series, X1 and Mini; Stellantis (previously Groupe PSA) on the Citroën C3, C3 Aircross, DS3, Crossland 208, 2008 and Corsa; and DPCA on the Citroën C-Elysee.

Dual Pinion EPS (**DPEPS**) allows for the primary pinion to be optimised for vehicle dynamics and performance and a secondary pinion to be optimised for steering assist. In 2019, we received our first DPEPS programme award with a major European OEM which will launch in 2023. In 2021, we announced new high-output options for DPEPS and SPEPS systems that increase the steering capability of these systems to support heavier EV loads in B through D segment vehicles.

Column-assist EPS (**CEPS**) integrates system electronics (motor, controller and sensor) and the assist mechanism with the steering column. OEM customers that use our CEPS include: SGM on the Buick Encore GX and Chevrolet Trailblazer; SGMW on the Wuling Victory (Kai Jie); and Stellantis (previously FCA) on the Fiat 500, Fiat Panda, Lancia Ypsilon, Fiat Uno, Fiat Mobi, Fiat Argo, Fiat Cronos and Fiat Strada.

In 2021, we launched our new Modular CEPS (**mCEPS**) system, which offers a cost-efficient, modular platform design achieving scalability for Nexteer and flexibility to meet a wide range of OEMs' requirements. Nexteer has secured a contract for its mCEPS technology with a leading Chinese domestic OEM, with plans for vehicle production to begin in 2022. In China, we also offer a cost-competitive brush motor column-assist EPS (**BEPS**) specifically tailored for developing markets. OEM customers that use our BEPS include: SGMW on the Wuling Hongguang S/S3 minivan, Baojun 730 MPV and Baojun 510 SUV; Changan on the Oushang MPV, CS15 SUV; and RNM on the Renault Kwid, Kiger and Triber.

HYDRAULIC POWER STEERING (HPS)

HPS uses high pressure fluids to assist driver steering. An engine-driven power steering pump creates system pressure. Pressurised fluid is then routed into a steering gear cylinder that turns the wheels of the vehicle. OEM customers that use our steering gears include: GM on its heavy-duty trucks (Chevrolet Sierra and GMC Silverado); and large vans (Chevrolet Express and GMC Savana); and Stellantis (previously FCA) on various light commercial vehicles (e.g. Doblo and Promaster). OEM customers that use our steering pumps include: GM and Isuzu.

Nexteer produces two premium hydraulic based products: Magnetic Torque Overlay (**MTO**) and Smart Flow pump. These products bring advanced driver assistance functionality with reduced power consumption benefits. The MTO steering gear actuator targets medium and heavy-duty trucks, semi-trailer trucks and buses. The Smart Flow pump reduces parasitic loss on the engine to improve operating efficiency. We also introduced an MTO cartridge valve that enables integration with OEMs' current gear configurations. MTO and Smart Flow pump are currently available on GM heavy-duty trucks (GMC Sierra and the Chevrolet Silverado). Smart Flow Pump is also available on GM's large vans (Chevrolet Express and GMC Savana). Through Nexteer's partnership with R.H. Sheppard, MTO is also available on Navistar class 8 trucks.

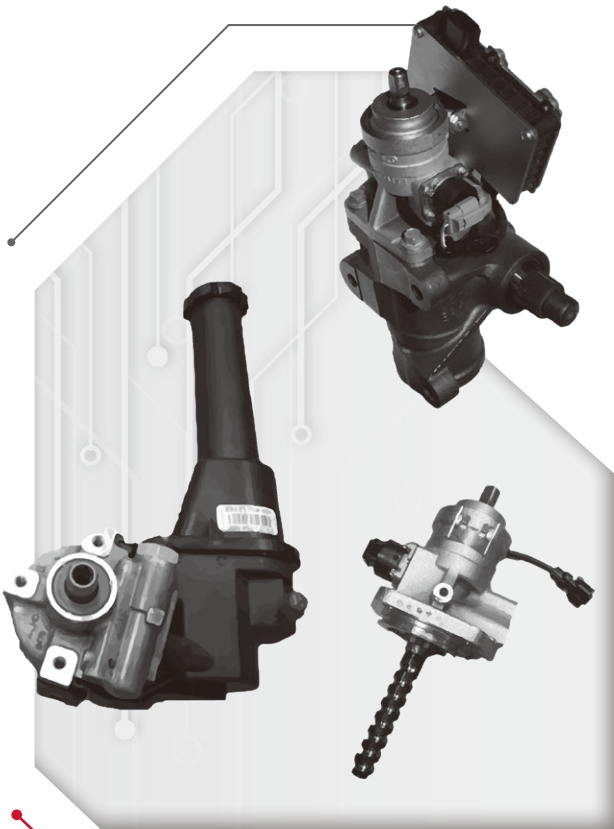

Our Products & Technologies

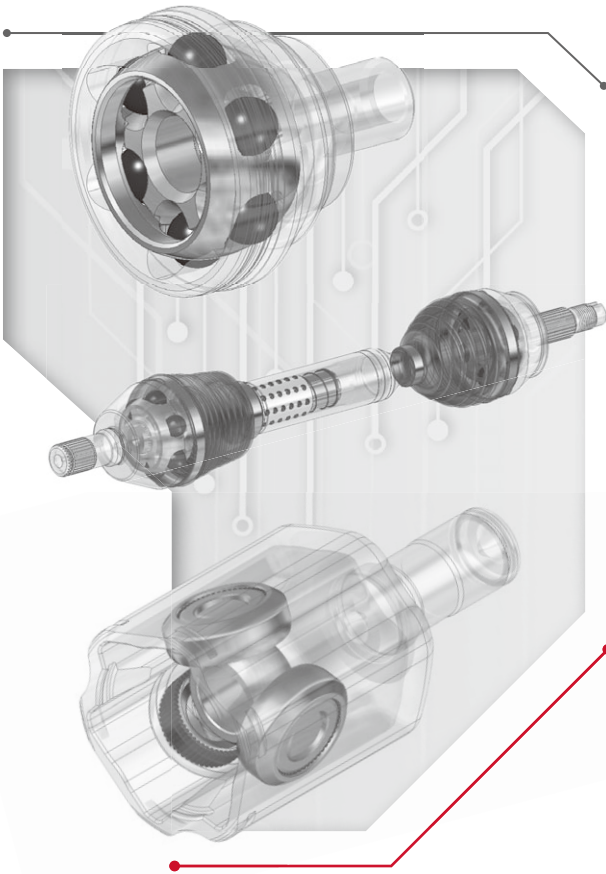
**DRIVELINE SYSTEMS (DL)**

DL systems are designed for a variety of vehicle segments and are custom engineered to meet specific vehicle requirements, transmitting torque from the engine to roadwheels. Our systems enhance vehicle handling and eliminate driveline disturbances on front wheel and all-wheel drive vehicles. Consequently, Nexteer's halfshafts enhance a driver's comfort and control.

Achieving best-in-class comfort and control – especially in terms of DL Noise, Vibration and Harshness (**NVH**) – becomes even more challenging with EVs that are extremely quiet. Nexteer DL solves for these increased NVH requirements with premium, high efficiency outboard joints, ball spline axles and lower mass components. OEM customers that use our DL technologies include: GM on the Chevrolet Silverado, GMC Sierra, Chevrolet Traverse, Chevrolet Blazer, GMC Acadia, Buick Enclave, Cadillac XT6 and XT5; Ford on Explorer and Aviator; RNM on the Dacia Logan and Sandero; Stellantis (previously PSA) on the Peugeot 208; and Stellantis (previously FCA) on the Chrysler 300 and Dodge Charger and Challenger.

STEERING COLUMNS AND INTERMEDIATE SHAFTS (CIS)

CIS connect the steering wheel to the steering mechanism, to control lateral motion by transferring the driver's input torque from the steering wheel. Our advanced steering columns provide convenience features and help protect the driver in the event of a crash. Convenience features include manual and power adjustability, theft deterrence, sensors, actuators and ergonomically designed controls. Advanced energy absorption systems help improve vehicle safety ratings and include our active systems that automatically compensate for the position of the driver to deliver optimum crash protection.

We design these products for all vehicle segments – small cars, SUVs and trucks. OEM customers that use Nexteer steering columns and/or intermediate shafts include: GM on full-size SUVs (Chevrolet Tahoe and Suburban and GMC Yukon), vans (Chevrolet Express and GMC Savana), mid-size trucks (Chevrolet Colorado and GMC Canyon) and cars (e.g., the Cadillac CT4, CT5, and Chevrolet Camaro); Ford on full-size trucks (F150 and Super Duty), full-size SUVs (Ford Expedition and Lincoln Navigator), vans (Ford E-series), mid-size trucks (Ford Ranger), mid-size SUV (Ford Explorer and Lincoln Aviator); Stellantis (previously FCA) on Dodge Ram full-size trucks, Promaster City and Doblo; Jeep Grand Commander, Wrangler and Gladiator as well as the Chrysler Pacifica; plus Toyota on full-size trucks (Tundra) and full-size SUVs (Sequoia).

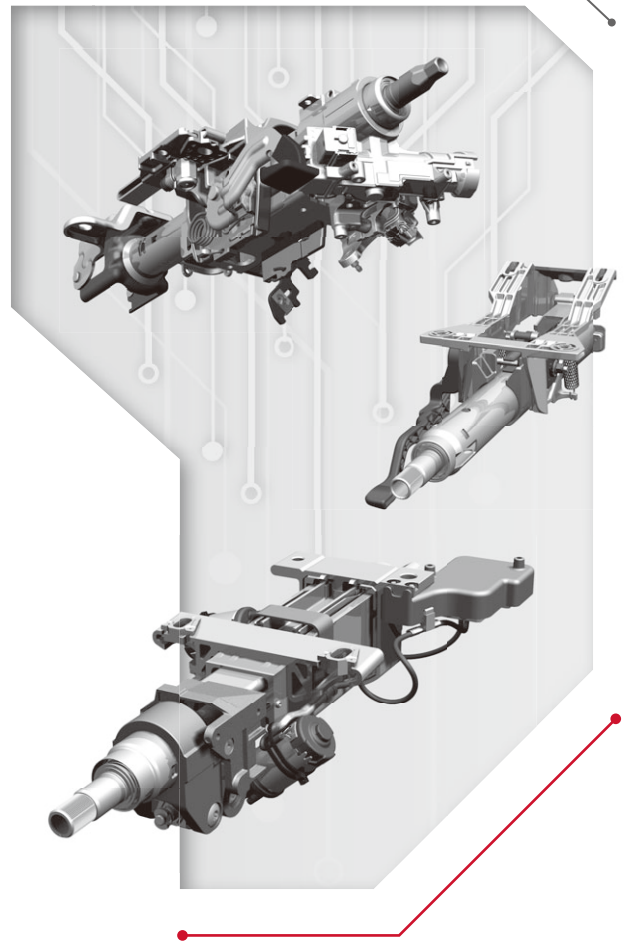

Our Products & Technologies

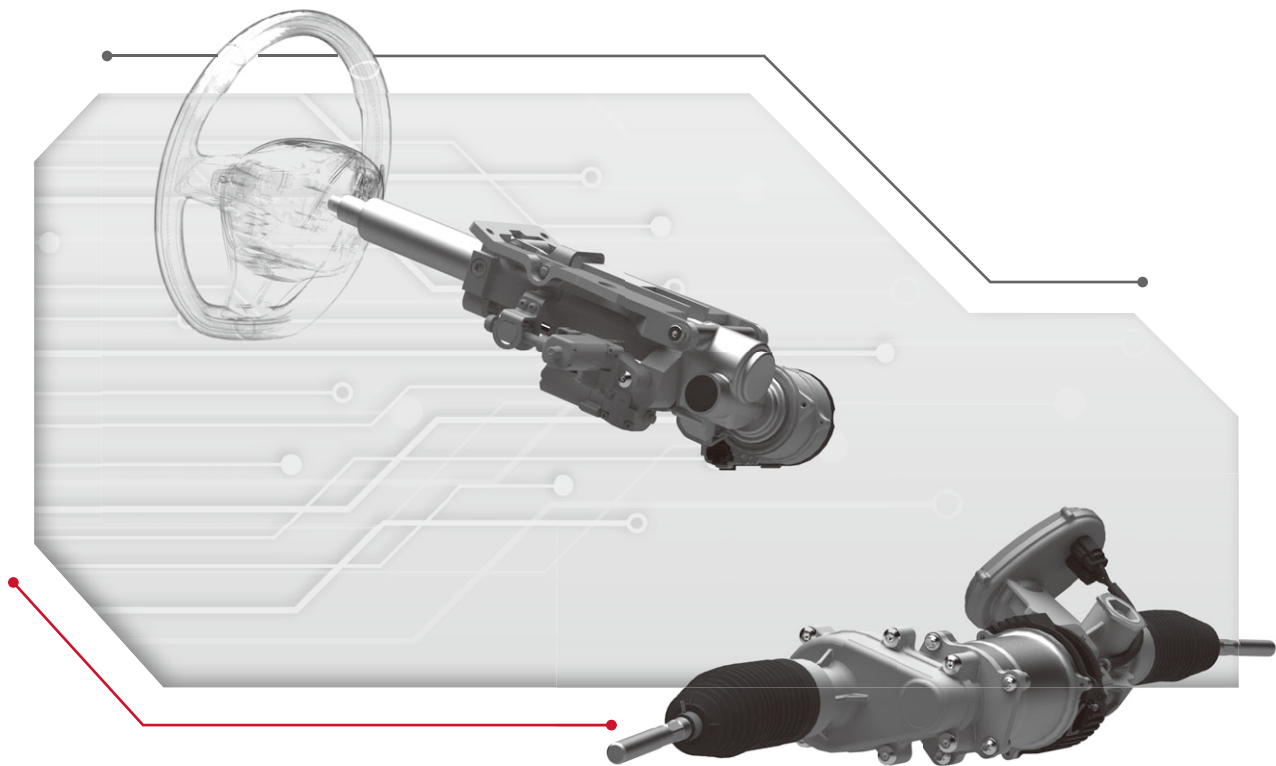

ADVANCED DRIVER ASSISTANCE SYSTEMS (ADAS) AND AUTOMATED DRIVING (AD) ENABLING TECHNOLOGIES

Through Nexteer's comprehensive suite of advanced steering technology, we are enabling a new era of safety and performance for today's world and an increasingly electrified and automated future. Our industry-leading innovations and solutions each stand on their own merit, but the real game-changer is the integration of these advanced technologies into tailored motion control solutions for OEMs. Our advanced steering technology suite supports Society of Automotive Engineers (SAE) ADAS Levels 1–5.

Steer-by-Wire (SbW): As the centre link of this suite, SbW opens the gateway to benefits that are not achievable with traditional steering solutions – enabling an untapped new frontier of advanced safety and performance features for traditional and autonomous driving. SbW can enhance stability control, reduce braking distances, and is a preferred enabler for Park Assist and Automatic Emergency Steering (AES). Beyond safety and performance features, SbW also enables packaging and design benefits with more flexibility in front of dash design and under-hood packaging, plus reuse of components across right-hand drive and left-hand drive platforms.

With SbW, the mechanical connection between the road wheels and the steering wheel is replaced with algorithms, electronics and actuators on the steering column and rack. Nexteer's SbW emulates the "feel of the road" and offers a wide performance range – from sporty to luxury. The system's variable steering ratio capabilities enhance maneuverability, and enables custom steering feel and precise feedback at all vehicle speeds.

High Availability EPS: Our award-winning High Availability EPS system ensures the steering safety net is always on through intelligently optimised software designed for simultaneous, multi-path processing and hardware redundancies in torque and position sensors, ECUs, motor windings as well as dual sets of vehicle power and communication connectors. These systems are capable of <10 failure in time (FIT) reliability ratings (FIT is measured per one billion hours of use).

ADVANCED DRIVER ASSISTANCE SYSTEMS (ADAS) AND AUTOMATED DRIVING (AD) ENABLING TECHNOLOGIES *(Continued)*

Quiet Wheel™ Steering: Enabled by SbW, Quiet Wheel™ Steering allows the steering wheel to remain still during AD mode – even while the vehicle is in the process of turning. Quiet Wheel™ Steering eliminates potential distractions and hazards of a fast-rotating steering wheel in front of the driver during hands-off driving, enhancing safety and sense of peace in the cabin.

Stowable Steering Column: Our Stowable Steering Column utilises custom-designed software and electronics that allow the steering wheel to be retracted into the dash and away from the driver when not in use. Stowable Steering Column also provides innovative solutions for crash safety, with ASIL-D steering column positioning. Nexteer is targeting to launch its first-to-market stowable column application with a major OEM by early 2025.

When paired together, Nexteer’s award-winning SbW with Stowable Steering Column opens a new world of cockpit design options and changes how drivers can use their vehicles – creating the opportunity for OEMs to re-invent and re-purpose the driver’s cabin space. For example, when SbW is coupled with a Stowable Steering Column during automated driving, additional space is created for the driver to engage in other activities. This technology can also be used for traditional driving vehicles; when the vehicle is in park, Nexteer’s Stowable Steering Column can extend the usable space in the vehicle cabin, creating a more spacious “office-on-wheels”.



EPS as Key ADAS Enabler: EPS converts data from the vehicle’s ECUs into mechanical steering functions. Typical EPS-enabled ADAS features include: lane keeping, park assist, traffic jam assist and lane departure warning.

Cyber-Secure Advanced Steering: While our customers incorporate cyber security at the vehicle level, we further enhance safety by integrating multi-layer cyber security at the steering system level for increased protection. Our cyber security technologies consist of specifically designed hardware modules at the semi-conductor level, as well as a multi-layered cryptographic software structure, that identifies and authorises information and command flow between the steering system and other in-vehicle or external controllers.

MTO: Our MTO delivers ADAS capabilities for drivers of heavy-duty trucks and up to Class 8 commercial vehicles. These ADAS features improve comfort, reduce driver fatigue as well as enhance safety for both the truck driver and others sharing the road. MTO-enabled ADAS features include: lane keeping, pull compensation, lane departure warning, wheel imbalance rejection, active damping and return to centre. Before MTO, these features were found only in lighter vehicles capable of being steered by EPS.

In the Business Overview of this report, learn how Nexteer technologies align with industry global megatrends, including electrification, software and more.

Our Products & Technologies

ADVANCED SAFETY & PERFORMANCE

Nexteer's Leadership in ADAS / AD Landscape

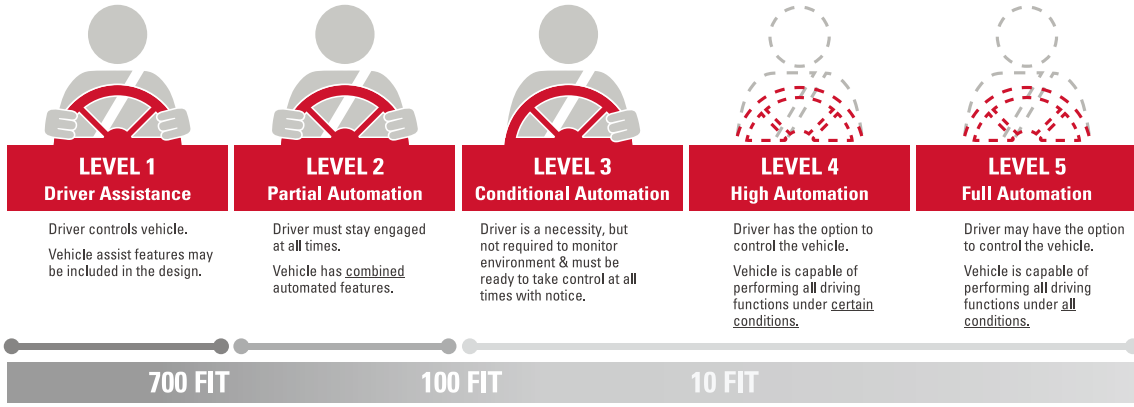

FIT: A Statistical Measure of Product Reliability. Lower FIT Scores Indicate Higher Product Reliability.

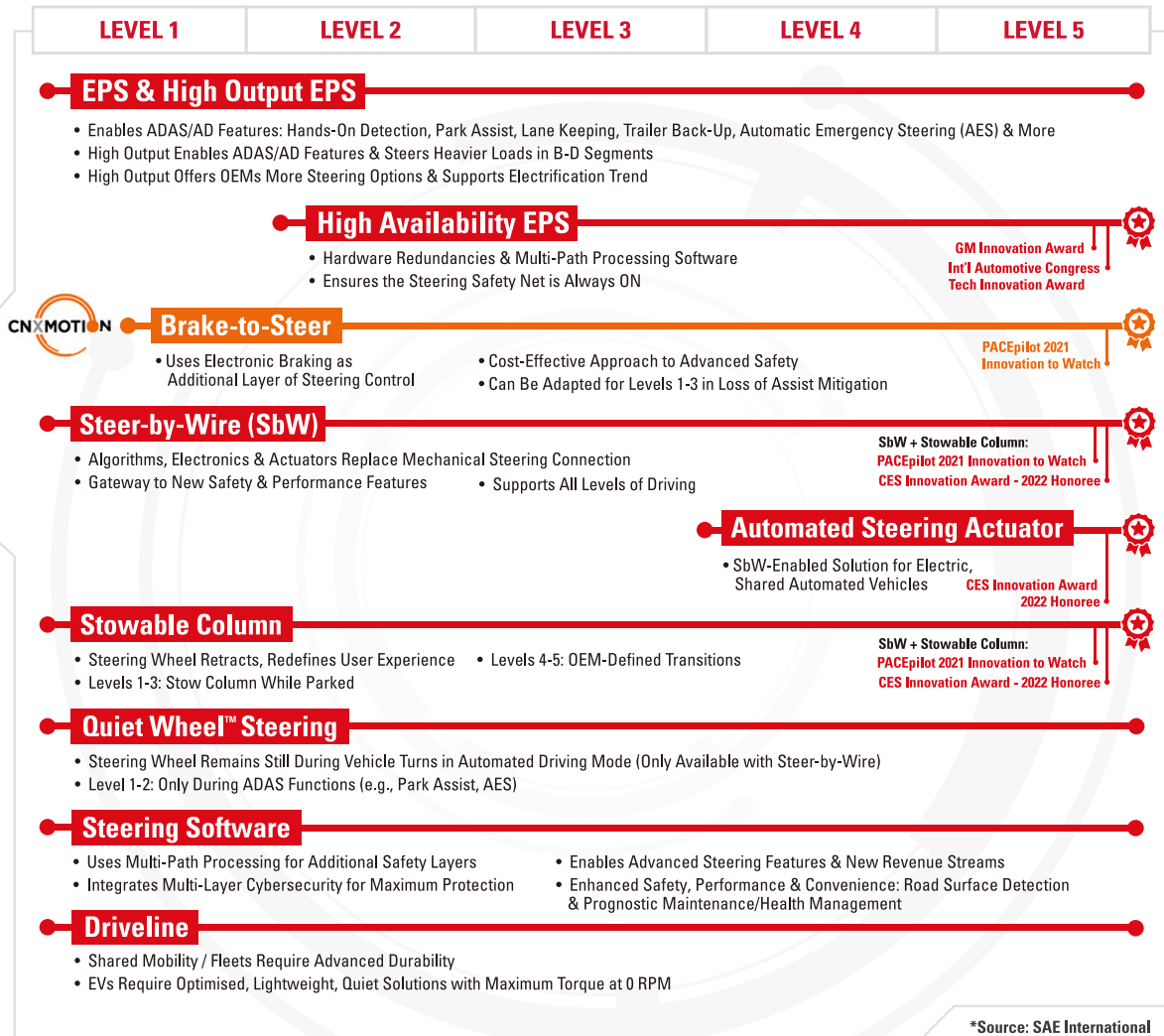

*Source: SAE International



BUSINESS OVERVIEW

Business Overview

STRATEGY FOR PROFITABLE GROWTH

We are committed to our six-point strategy for profitable growth to drive shareholder value. Our strategy for profitable growth served as our guidepost through the unprecedented environment we navigated through during the course of 2020 and 2021. This strategy continues to guide our daily decision-making as we move forward by defining and adjusting our business to align with the changing landscape and new challenges within the global automotive industry.

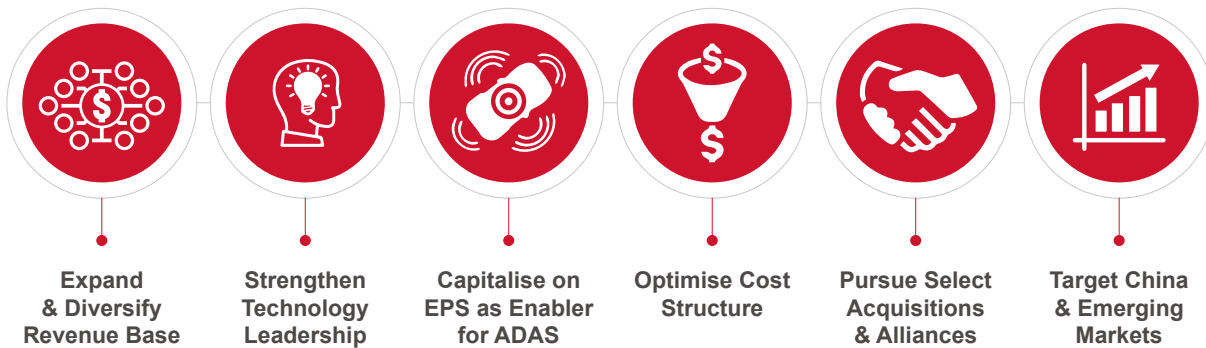
**Strategy for Profitable Growth****2021 BUSINESS HIGHLIGHTS**

The following highlights demonstrate Nexteer's focus on delivering long-term profitable growth:

- Successfully launched 36 new customer programmes across all product lines and regions – marking another year of strong programme launches. Of these customer programmes, 32 represented new or conquest business and 15 represented EV launches supported by our products
- Customer programme Bookings totaling US\$5.9 billion, of which 28% represented conquests from competitors, including breakthrough steering wins with a Japanese OEM, a segment leader in the utility and all-terrain vehicle field, a global EV leader and multiple NEV start-ups in China
- Recorded Order-to-Delivery Backlog of Booked Business of US\$26.8 billion – a record high for Nexteer
- Continued commitment to technology leadership and megatrend alignment for future growth – including electrification and software megatrends
- Honoured for innovation, quality, excellence and exceptional customer relationships – including prestigious *Automotive News* PACEpilot Innovation to Watch and Consumer Electronics Show (CES) Innovation awards

NEW PRODUCTION LAUNCHES

With the launch of 36 customer programmes in 2021, we introduced new or enhanced product applications in steering and DL across all regions and vehicle segments. These programmes represented both global and local vehicle nameplates – of which 32 launches represented new or conquest business and 15 represented EV platforms. Customer programmes that began production in 2021 included:

OEMs	Vehicle Nameplate	Our Products
North America		
Stellantis	Jeep Grand Cherokee	REPS
Ford	Ford Bronco	Columns, REPS
GM	Chevrolet Bolt EUV	Halfshafts
	GMC full-size Van EV	Columns, REPS, Halfshafts
	GMC Hummer EV – Pickup	Columns, Halfshafts, REPS
R.H. Sheppard	HD94-Class 8	MTO
EMEASA		
BMW	BMW 1-Series Active Tourer	SPEPS
	BMW iX	Columns
RNM	Renault Kangoo	Halfshafts
	Renault Kangoo EV	Halfshafts
	Dacia Express	Halfshafts
Stellantis	Fiat Pulse	CEPS
Asia Pacific		
Mahindra & Mahindra Limited	Mahindra XUV500	Halfshafts
Daimler AG	Mercedes-Benz C-Class	Halfshafts
Ford	Ford Escort	Columns
Guangzhou Automobile Group Co., Ltd.	Guangzhou Auto Aion Y	CEPS
Zhejiang Geely Holding Group Co., Ltd.	Zeekr 001	REPS
GM	Chevrolet Bolt EUV	CEPS, Halfshafts
GWM	Havel H6	CEPS
	Havel Hover H9	Columns
RNM	Infiniti QX60	Halfshafts
	MMC Outlander PHEV	Halfshafts
	Nissan Pathfinder	Halfshafts
	RNM Kwid	CEPS
	Samsung Arkana	Halfshafts
Tata Motors Limited	Tata Limber EV	Halfshafts
VG	Skoda Kamiq	Halfshafts
	Skoda Rapid	Halfshafts
	Volkswagen Taigun	Halfshafts
	Volkswagen Polo	Halfshafts

Business Overview

MANAGING OPERATIONAL, SUPPLY CHAIN, COMMODITY AND LOGISTICS CHALLENGES

As economies across the globe reopened during the second half of 2020 with a strong recovery extending through the first half of 2021, the automotive industry experienced – and continues to experience – new challenges in meeting increasing demand. Global electronics supply shortages emerged in the first quarter of 2021 and accelerated through the rest of the year, adversely impacting many of our customers' vehicle production schedules due to components shortages across the supply chain. While COVID-19 vaccination and other health treatments continue to be aggressively rolled-out around the world, many countries continue to be impacted by the spread of new virus variants which have hampered many industry participants in meeting demand. The current supply/demand imbalance has resulted in rising input costs for certain commodities and significant increases in both time and cost for logistics impacting sea freight capacity, container availability and port congestion.

2021 revenue totaled US\$3.4 billion, an increase of 10.8% when compared with 2020. Adjusting for foreign currency and commodity recoveries from our customers, Nexteer's revenue increased by 7.2%, outperforming the increase in global OEM vehicle production of 2.5%, by 470 basis points. This outperformance compared with market reflects the continued benefit realised from new and conquest customer programme launches and favourable vehicle mix.

Despite a significantly challenging operating environment, 2021 net profit attributable to equity holders of US\$118.4 million was 1.4% higher when compared with 2020.

While the elevated cost environment and volatile customer vehicle assembly production requirements proved to be a headwind to our 2021 financial results, Nexteer proactively and diligently worked with both our OEM customers and supply partners to minimise the impact of supply shortages to our customers through component substitutions, alternative supply arrangements, throughput improvements and other levers within our control. We continue to closely collaborate, monitor and, as possible, reallocate supply to where needed to best support all customer production schedules.

We also continue cost reduction efforts as well as cost recovery discussions with customers to partially mitigate the inefficiency from frequent OEM production schedule changes and rising direct input costs such as commodities and logistics.

While the operating environment in 2021 was quite challenged, we remain optimistic and confident as industry macro fundamentals remain robust including strong consumer demand, historically low vehicle inventories and continued economic recovery.

BOOKINGS AND BACKLOG OF BOOKED BUSINESS

2021 BOOKINGS: ALIGNED FOR CONTINUED GROWTH

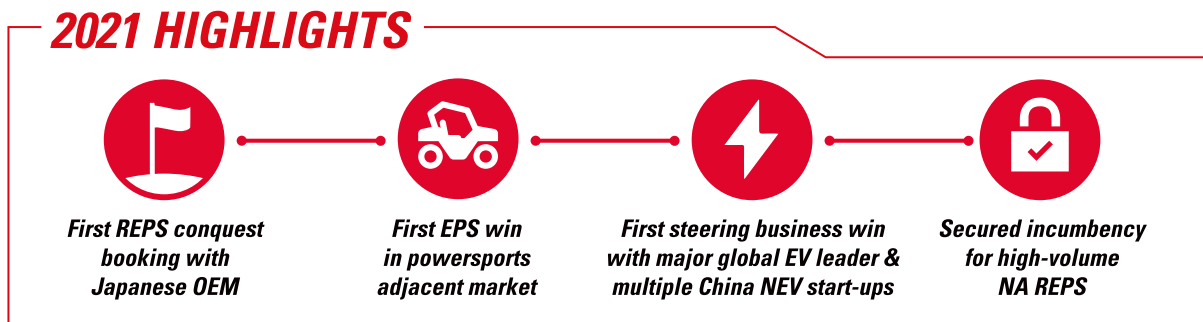

In 2021, we continued to focus on expanding and diversifying our revenue base – expanding our sights beyond our current foundational customers by targeting growth with additional global OEMs to expand our market position and revenue growth with our core products. We had a strong year of Bookings and accomplished several notable successes although global supply chain constraints did delay some customers’ programme nomination processes.

Most notably in the first half of 2021, Nexteer secured our first REPS conquest Booking with a Japanese OEM. This award further strengthens our technology and global market leadership for REPS broadly, and specifically opens opportunities for introduction and expansion of our other product line offerings to this Japanese OEM.

In the second half of 2021, Nexteer secured our incumbent position on a high-volume North America REPS programme. Nexteer also broke into the adjacent market with a powersports vehicle – winning our first EPS programme with the segment leader in the utility and all-terrain vehicle field. We also achieved significant progress with a major global EV leader and booked our first steering business (steering column) with them. We also booked business with multiple NEV start-ups in China — for power columns and EPS. We continue to build on this initial success in pursuit of additional programmes with NEV leaders in the region.

BACKLOG OF BOOKED BUSINESS

We begin to realise revenue under a new business contract as steering systems and DL products are first shipped to vehicle manufacturers at the time of product launch. Product launches have historically lagged the date of contract award by an average period of 24 to 30 months. We have calculated a booked business backlog value (the **Backlog of Booked Business, Booked Business or Backlog**) which includes the value of awarded business for as yet, undelivered product generating revenue between the time of launch through the end of the life of the respective award. A significant factor and input into the calculation of Nexteer’s Backlog of Booked Business is forward year OEM production forecasts for awarded customer programmes. In determining forward year OEM production expectations, Nexteer considers reputable third-party automotive production forecasts, customer expectations and internal industry knowledge given past and current trends.

We estimate the value of all Booked Business under customer contracts that have been awarded, but for which we have undelivered products, was US\$26.8 billion as at December 31, 2021 compared with US\$24.6 billion as at December 31, 2020.

Bookings and the value of Booked Business are not measures defined by International Financial Reporting Standards (IFRS), and our methodology for determining Bookings and the Backlog may not be comparable to the methodology used by other companies in determining the value of their bookings or booked business. Assumptions relative to estimated lifetime programme volumes and contract performance remain unchanged from our disclosures in prior periods. Any modification, suspension or cancellation of the contracts related to the Booked Business by the Group’s customers may have a substantial and immediate effect on the value of the Backlog. While we believe that our current Bookings and Backlog are relevant financial metrics, we must emphasise that the information set out in this section shall not constitute any forecast or prediction of the revenue and profits of the Group and the actual future value may differ from the estimated Bookings and Backlog due to various factors beyond the Group’s control.

Backlog of Booked Business

Backlog by Product Group

- EPS
- DL
- CIS
- HPS

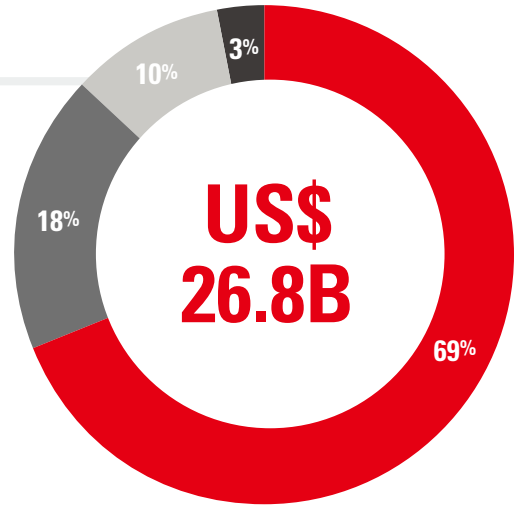

Backlog by Geographical Segments

- North America
- Asia Pacific
- Europe, Middle East, Africa and South America

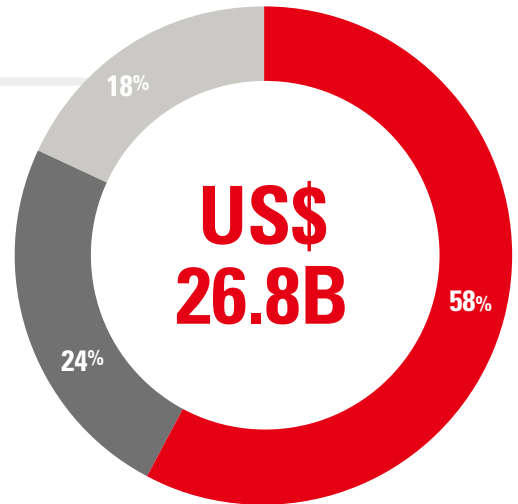

Backlog by Product Related to EVs

- Estimated % of EPS, CIS & DL Backlog for EV* Applications

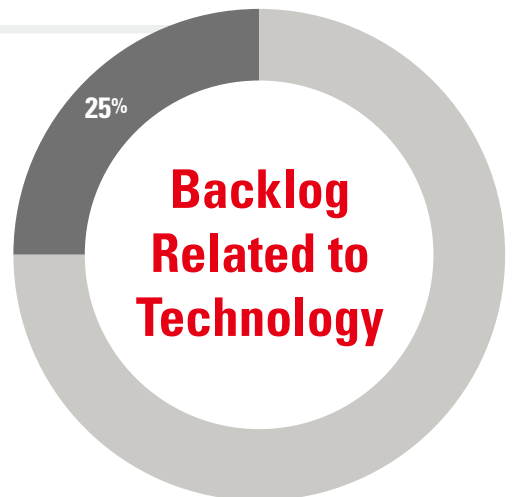

*EV Analysis includes:

- Battery Electric Vehicles
- Full Hybrid Electric Vehicles
- Plug-in Hybrid Electric Vehicles

INDUSTRY-LEADING STEERING TECHNOLOGIES: ALIGNED FOR CONTINUED GROWTH

Nexteer continues to leverage our deep technical competencies in developing innovative products and value propositions to drive future growth and customer diversification.

We leverage our in-house competencies to extend our suite of technologies and product offerings – including extension of our core products into technologies such as SbW, DPEPS, HO EPS, mCEPS, Stowable Columns and more. We continue to expand our capabilities in software development and leverage our expertise in electronics and motors and bring this accumulated expertise to the benefit of our customers in providing unique and innovative solutions.

In 2021, Nexteer made announcements related to three of our industry-leading steering technologies – mCEPS, HO EPS and SbW – and how they position Nexteer for continued growth.

Introduction of Modular Column-Assist EPS

Nexteer's mCEPS offers a cost-efficient, modular platform design achieving scalability for Nexteer and flexibility to meet a wide range of OEMs' requirements. mCEPS creates new possibilities for vehicle types that have used traditional CEPS systems in the past. With a platform design and an expandable electronic control system, mCEPS allows Nexteer to meet OEM customers' needs for an advanced, customisable and cost-effective steering system that is flexible to customer packaging and other requirements.

Our mCEPS system is available in three models – Standard, Enhanced and Pro – to support various load capacities and other requirements. For example, mCEPS Pro supports SAE ADAS levels 2–5, as well as over-the-air (OTA) updates and cybersecurity. All three Nexteer mCEPS models are based on AUTOSAR Release 4.0 electrical/software architecture. In addition, Nexteer's custom-developed, high-performance torque and rotation angle sensors provide outstanding NVH performance and a smooth and accurate steering feel – making drivers feel more connected to the road.

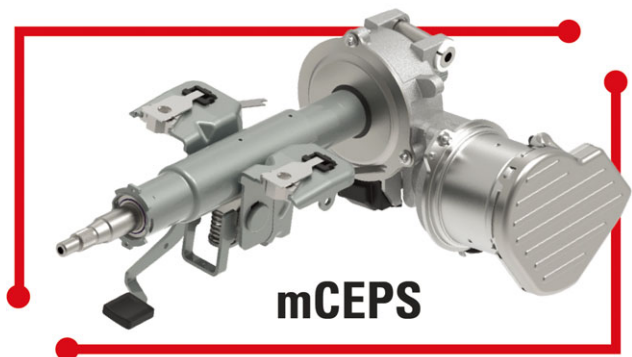

Nexteer's Technical Centre in Suzhou, China leads mCEPS architecture development and is another example of how we are continuing to expand localised technical expertise and capability across our global footprint. Our new mCEPS, along with other new steering technologies such as HO EPS and DPEPS, positions Nexteer to provide a full spectrum of EPS product offerings – allowing us to steer all vehicle types and sizes.

Business Overview

HIGH OUTPUT EPS: ELECTRIFICATION TREND & INCREASED STEERING CAPACITIES

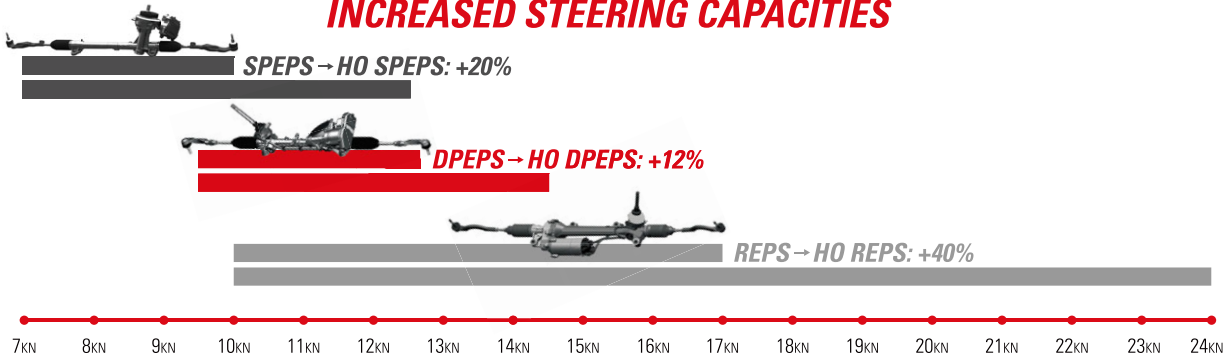

Expansion of High-Output EPS (HO EPS) Solutions: Spans B-D Vehicle Segments, Plus LCVs & HD Trucks (in the 3.5–6T Segment)

As EVs drive higher tie rod loads in all vehicle segments, Nexteer has expanded the output capabilities of our pinion EPS systems to meet these higher EV loads for B through D vehicle segments.

New high-output options for our DPEPS and SPEPS systems increase the steering capability by 12 to 20% – up to 14.5 kilonewtons (kN) for DPEPS and up to 12.5kN for SPEPS. These high-output solutions benefit OEM customers by enabling them to steer heavier EV loads in B through D vehicle segments without the need to utilise more premium EPS technologies traditionally employed for larger segment vehicles.

In addition to our new HO DPEPS and HO SPEPS systems, Nexteer’s HO REPS increases the steering capacity of Nexteer’s industry-leading REPS – steering up to 24kN of load compared with 10-17kN for a typical REPS system. In addition to EVs, which are in many cases heavier than comparable internal combustion engine (ICE) platforms, HO REPS can also convert heavy-duty (HD) trucks and light commercial vehicles (LCV) from hydraulic to electric power steering. For example, the BrightDrop EV and GMC Hummer EV will be utilising our HO REPS systems. Now with the ability to steer these vehicle types electrically, drivers of HD trucks and LCVs can benefit from enhanced fuel efficiency, advanced safety and comfort features such as lane keep assist, crosswind compensation, trailer assist and more.

With high-output options for all under-hood steering systems (SPEPS, DPEPS and REPS), Nexteer’s expanded product portfolio spans B-D vehicle segments, as well as LCVs and HD trucks (in the 3.5–6T segment). This product expansion further enhances the Company’s position within the growing electrification trend – as well as capitalises on our global market leadership in REPS and market leadership with SPEPS in Europe. Our expanded product portfolio further strengthens our incumbent customer positions and offers opportunities for continued expansion of our customer base and market diversification.

Readiness of SbW

Nexteer views SbW as being the “centre link” connecting the automotive megatrends because the technology supports connected, shared, autonomous and electrified vehicles of the future. SbW will likely evolve into the preferred steering technology of future vehicles.

As the industry’s interest in SbW increases, Nexteer is capitalising on its SbW technology leadership. In this competitive industry, OEMs are looking for supplier partners that can deliver the highest level of technology, quality and safety. With our motion control expertise and industry recognition as an advanced “steering specialist,” we are uniquely positioned to lead this technology trend and deliver the performance, safety and value enhancements that SbW enables.

Business Overview

Global OEMs have proactively sought Nexteer for our SbW technical competency. In 2021, Nexteer continued to work with two large global OEMs for future SbW programmes based on our development partnerships and involvement in creating SbW architectural requirements. In addition, Nexteer also started SbW development with a China domestic OEM partner, further strengthening the Company's leadership in this technology.

Nexteer is proactively developing SbW with modular building blocks that can be efficiently applied and tailored to meet the specific requirements of multiple OEMs. We also believe we have a lead in steering feel and production readiness based on feedback from multiple OEMs at our SbW demonstrations.

Overall, Nexteer is prepared to be a SbW leader based on our:

- Global, technology leading OEM development partnerships with high-volume production plans
- Industrialisation readiness and competitive footprint
- SbW with Stowable Column solution that is engineered by a "steering specialist" focused on safety, steering feel and performance

In 2021, Nexteer's SbW with Stowable Steering Column was recognised as a 2021 *Automotive News* PACEpilot Innovation to Watch and a 2022 CES Innovation Award Honouree. These prestigious awards provide further validation that the industry values these technologies and recognises Nexteer as a SbW leader.

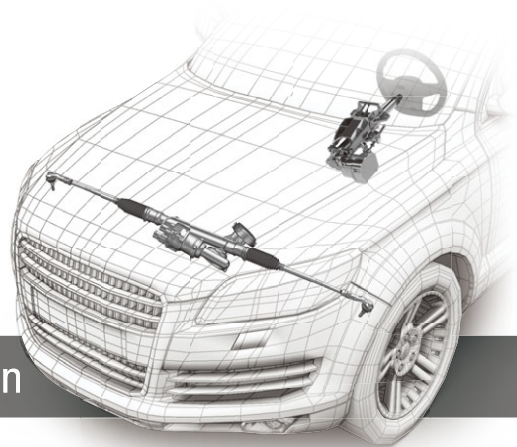

Steer-by-Wire with Stowable Column

Business Overview

TECHNOLOGY LEADERSHIP & PORTFOLIO-TO-TREND ALIGNMENT: ALIGNED FOR CONTINUED GROWTH

Megatrends influencing the automotive market and adjacent sectors represent new and unique channels for Nexteer’s continued growth. We are well-positioned to support OEMs’ future priorities in these areas.

Nexteer has a robust, proven technology and product portfolio to support industry megatrends like Electrification, Software, Connectivity, ADAS – Advanced Safety and Performance and Mobility-as-a-Service (**MaaS**). Being focused on where the industry is heading, through a strategic alignment on megatrends, contributes to our relevance and will help accelerate our growth.

Following are examples that demonstrate how these megatrends are evolving and intersecting and how Nexteer is well aligned to these trends and positioned to capitalise on in-house technology efficiencies to support OEMs’ shifting priorities.

Beyond these examples and our current product portfolio, Nexteer’s global research and development (**R&D**) team also continues to explore new ways to further capitalise on megatrends and offer innovative solutions to OEMs’ evolving product challenges.

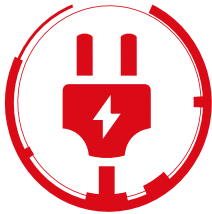

Electrification

Vehicle electrification is providing an opportunity not only to grow and expand our products, but to do so with increased profitability and content per vehicle as our technologies across all product lines continue to participate successfully in the electrification trend.

STEERING FOR EVs



Highly Capable Steering Technologies



Meet Unique Requirements for Both EV & ICE



High-Quality NVH Performance

From a steering perspective, Nexteer is prepared to support unique electrification needs by:

- Offering premium, high capability steering technologies capable of handling EVs’ heavier load requirements – which are driven by increased battery weight
- Offering high-output, under-hood EPS systems that can meet the unique requirements of both EV and ICE variations (as EV models of current ICE models are introduced)
- Focusing on steering sub-system acoustic and vibration performance because of new challenges in NVH, as typical ICE vehicles tend to mask noise that a quiet electric motor does not

From a DL perspective, EVs present unique challenges such as:

- Need for low mass, compact solutions to help accommodate batteries
- Increased NVH requirements due to the quietness of EVs
- Expanded fatigue requirements due to increased torque and regenerative braking duty cycle

Nexteer offers advanced DL solutions to meet these needs including:

- Low mass, compact halfshaft designs to accommodate packaging constraints and reduce vehicle weight – thus improving battery driving range
- Halfshafts with premium, specialised joints to meet increased NVH requirements
- High efficiency joints that support CO₂ emission reductions and improve battery driving range

DRIVELINE FOR EVs



Low Mass, Compact Solutions



Premium NVH Performance



High Durability & Robustness

Business Overview

We also continue to make strategic product expansions across our product lines to protect and grow market share within this trend, particularly in the electric pickup truck segment. Our HO REPS and Ball Spline Axle Halfshaft are two examples of how well Nexteer is positioned in the convergence of electrification and the truck segment. Both technologies are featured in the new GMC Hummer EV that launched in 2021. In April 2021, GM announced that a new EV pickup truck, the electric Chevrolet Silverado, will launch in 2023 – also featuring all of Nexteer’s product lines, including our HO REPS, Ball Spline Axle Halfshaft and steering column. Similarly, the EV version of the Ford F150 pickup truck, which is planned to launch in early 2022, will utilise our REPS system with 10-FIT High Availability technology, as well as our power steering column. These industry-leading technologies further strengthen our leadership position in the critical North American truck market.

eDrive: Launches eDrive Product Line as a Cost-Effective Approach to Reducing Emissions, Combines Steering & Driveline Expertise

Nexteer is further capitalising on the electrification trend and expanding its product portfolio with in-house technology building blocks. In early 2022, Nexteer announced a new eDrive product line with the launch of a 48-volt Integrated Belt-Driven Starter Generator (**iBSG**) that hybridises conventional internal combustion engine (**ICE**) vehicles. Nexteer’s innovative, cost-effective approach helps OEMs meet emissions and fuel efficiency regulations and enhances driving comfort for end consumers.

The launch of Nexteer’s eDrive product line combines decades of experience and technical expertise from existing product lines such as EPS and Driveline. In the development of its new 48-volt iBSG eDrive product, the Company leveraged expertise in motors, controls, software and electromechanical systems integration. In addition to combining technical expertise from existing product lines, Nexteer also leveraged its quality manufacturing systems, scalable supply chain and global footprint of technical centres and manufacturing locations.

Nexteer has secured a contract for its 48-volt iBSG eDrive product with a leading Chinese domestic OEM, with plans for production in the first half of 2022. This launch creates a foundation and entry point for the Company’s exploration into additional eDrive applications and customer expansion.

Nexteer’s 48-volt iBSG eDrive is a highly integrated electro-mechanical propulsion system that is connected to the engine crankshaft through a belt. It is equipped with a high-efficiency electric motor, power electronics and advanced control software. This compact, cost-effective device serves as an additional power source that hybridises ICE vehicles.

In addition, 48-volt iBSG improves fuel efficiency by using an electric motor to increase the efficiency of the ICE vehicle. The 48-volt iBSG recoups the vehicles kinetic energy during deceleration and returns this captured energy during acceleration to boost the ICE and fuel efficiency. Furthermore, the 48-volt iBSG enhances driver comfort during engine startup and transmission gear shifting processes – while also achieving the same driving performance requirements.

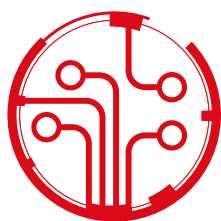

Software & Connectivity

As vehicles are fast becoming more software-enabled, cloud-connected devices, global OEMs’ needs are growing exponentially in software-enabled steering features and other software-centric motion control applications.

Software plays an important role in today’s vehicles related to advanced safety and performance. For example, steering software plays a crucial role in optimising steering assist and feel, as well as enabling ADAS features such as park assist, lane keeping, lane departure

warning, traffic jam assist and more.

In addition to software-enabled driver-assist features, OTA software updates – including steering applications – will continue to expand. Longer-term, automotive software will also play a key role in enabling motion control of autonomous vehicles, as well as offering stand-alone software “purchases” for new advanced safety and performance features. This trend is critically important as today’s hardware-defined vehicles are rapidly transforming into software-defined transportation platforms.

Business Overview

As the megatrends evolve and converge, a common safety requirement also underpins them all – cybersecurity. Nexteer has proactively developed cybersecurity solutions by partnering with our OEM customers, to ensure that the steering system is safe and protected.

Software Partnership: Tactile Mobility

Nexteer announced the expansion of our growing software capabilities with an investment in Tactile Mobility in January 2021. Tactile Mobility is a leading tactile, virtual sensing and data company based in Israel. The collaboration between Nexteer and Tactile Mobility focuses on motion control software to enable advanced software offerings that maximise OTA updates and connectivity for even safer, more reliable driving. Our collaboration with Tactile Mobility complements the Company's existing global software business model and focus on motion control software by helping build-out even more of Nexteer's software offerings. For example, it will allow Nexteer to expand our road friction detection capabilities with cloud-based technology and machine learning.

nexteer
AUTOMOTIVE

+

TACTILE
MOBILITY

ROAD SURFACE DETECTION & TIRE HEALTH MONITORING SOFTWARE

- Detects Changing Road Surfaces & Evolving Tire Conditions
- Enhances the Real-Time Connection Among Driver, Vehicle & Road
- Improves Safety, Performance & Vehicle Health Management

In early 2022, Nexteer and Tactile Mobility announced advanced road surface detection and tire health monitoring software to improve vehicle health management, safety and performance. This new software highlights how Nexteer is combining its expertise in EPS software and steering feel tuning with Tactile Mobility's sensing technology and data analytics to improve a vehicle's connection to the road and enable even safer, more reliable driving. Nexteer and Tactile Mobility have been engaging with key global OEMs and running demos to illustrate the benefits of this software technology.

Software Organisational Enhancement

To meet the ever-expanding software needs of our global OEM customer base, Nexteer announced that we elevated our global Software Engineering organisation in April 2021. Our new organisational enhancement creates a single strategic software team across four global locations within Nexteer, including our Global Technical Centre in Saginaw, USA; Regional Technical Centres in Tychy, Poland and Suzhou, China, as well as our Software Centre in Bengaluru, India. Previously, software engineering expertise was dispersed among various teams throughout the Company and reported separately through product lines and R&D. The newly formed team reports directly to the Company's Chief Technology Officer (CTO).

Nexteer's centralised software team will support EPS systems and advanced steering feature development. In addition, the new structure will also support software-related R&D projects including software solutions that could be cloud-based or reside within a centralised chassis domain controller.

We are accelerating our focus on software development, leveraging the scale and competency at our India Software Centre, as well as our other global technical centres. Our efforts in this area will position us well for future OTA updates and cloud-based connectivity services – leading to even safer and more reliable driving with vehicles that are in-tune with their environments in real-time.



ADAS – Advanced Safety & Performance

In the area of advanced safety and performance, Nexteer has several initiatives including Brake-to-Steer, which we announced in December 2020. This technology was developed by CNXMotion, LLC (**CNXMotion**), our joint venture with Continental Automotive Systems, Inc. (**Continental**), and it provides another safety layer of steering redundancy in highly automated and autonomous vehicles. In 2021, Brake-to-Steer was named an *Automotive News* PACEpilot Innovation to Watch – which recognises transformative innovations in our industry.

In addition to steering technologies like Brake-to-Steer, SbW and stowable steering columns, our near cylindrical 10 FIT folded circuit board power pack and Magnetic Torque Overlay (**MTO**) technologies also support the ADAS megatrend.

Near Cylindrical 10 FIT Folded Circuit Board Power Pack

Nexteer's near cylindrical 10 FIT folded circuit board power pack features our most compact, highest content design ever – a 10 FIT capable folded circuit board that enhances safety, cost savings and packaging space. Our new power pack achieves a low FIT rating through backup redundancies in the controller circuits and software and electronic connections that provide support for critical components – thus ensuring the safety net is always on. The 2021 Ford Bronco is the first to include this power pack design, which enhances safety for Bronco drivers based on backup redundancies in the controller circuits and connections.

The near cylindrical 10 FIT folded circuit board power pack also features a compact design that accommodates the motor's cylindrical diameter. The power pack's folded circuit board reduces cost compared to the usual separate, interconnected boards. This space-saving approach to power packs also provides OEM benefits for EVs. With large battery packs often located centrally and low in the vehicle, EVs require new considerations in terms of packaging compared to traditional ICE vehicles – thus technologies that provide packaging flexibility are critical.

This new power pack technology is ideally paired with one of our industry-leading EPS systems to enable advanced safety and performance with precise, predictable feel of the road. In the Ford Bronco, this new power pack is paired with Nexteer's REPS system, which enables additional driver-assist features like lane keeping and auto park assist, while also enabling OTA software flash updates.

Magnetic Torque Overlay

Nexteer has a partnership with R.H. Sheppard to provide our MTO and advanced driver-assist steering technology on commercial trucks. From an industry standpoint, Class 7/8 and coach bus vehicle regulations are adding requirements for autonomous safety content such as lane keeping assist to help reduce driver fatigue. The Nexteer and R.H. Sheppard MTO system has received very positive reviews from both commercial truck drivers and OEMs.

While Nexteer has been in production with our MTO technology for heavy-duty passenger truck applications since 2015, this partnership represents business expansion because it is our first programme within the commercial vehicle market segment. Production began on this product in January 2021 with Navistar, and we are currently in the launch phase, following a four-year development contract. Beyond Navistar, we continue to work through our partnership with R.H. Sheppard to engage multiple commercial OEMs with potential applications across various commercial truck classes.

Business Overview



Mobility-as-a-Service

In the area of mobility, we foresee that shared mobility trends will require advanced solutions from both our steering and DL product lines, as well as our CNXMotion JV. As the mobility trend evolves, built-in redundancies will be required as well as higher durability designs due to a significant increase of driving hours on shared fleet of vehicles over shorter time intervals. As highlighted previously, Nexteer is exploring solutions for shared mobility and last-mile delivery (LMD) services through strategic partnerships with GM's BrightDrop, Cruise as well as several others.

Fully automated people movers are a perfect example of Nexteer's repurposing technologies for different applications as well as an overlap across many megatrends such as MaaS, Electrification, ADAS Level 5 and Connectivity.

In 2021, Nexteer's Automated Steering Actuator was named a 2022 CES Innovation Award Honouree in the "Vehicle Intelligence & Transportation" product category.

Our Automated Steering Actuator offers a single steering solution that solves challenges for shared, autonomous and electric people mover vehicles – including those without a steering wheel or driver. It enables higher vehicle speeds, higher steering loads and higher safety and durability requirements.

The Automated Steering Actuator leverages SbW architecture so there is no mechanical connection between the handwheel and road wheels. It achieves high availability safety coverage through a combination of software, electrical hardware, mechanical and sealing redundancies. These redundancies ensure that a steering safety net is always ON – especially when there is no driver as a mechanical backup. It also supports the increased durability and reliability performance needed for shared autonomous vehicles because of heavier vehicle weights, higher rack forces and increased hours and miles on the road.

It removes the literal and figurative barriers of shared autonomous vehicles that are currently confined to geo-fenced, last mile, low speed, lightweight and neighborhood applications – making it a critical piece in the complex megatrend puzzle that brings together Electrification, MaaS and Autonomy.

We are currently working with an OEM customer to leverage our Automated Steering Actuator in a fully autonomous people mover that is self-driven, all-electric and is a shared mobility platform. This vehicle will not have a steering wheel, steering column or intermediate shaft.

INTELLECTUAL PROPERTY PROTECTION & TECHNOLOGY

Nexteer is dedicated to protecting our intellectual property rights, which are crucial to our business growth and our ability to differentiate ourselves from competitors. We actively apply for protection for Nexteer's intellectual property to guard our exclusive rights. As of December 31, 2021, Nexteer's global portfolio includes 795 patent applications and 1,126 issued patents. The sustained growth in issued patents is a result of our robust applications in previous years and it demonstrates our efforts for observing and protecting intellectual property rights. In alignment with industry megatrends, 25% of granted patents are related to Software-as-a-Product, Steer-by-Wire, and/or ADAS/AD enabling technologies. Additionally, 12% of our 2021 patent filings are directly related to these identified technologies. Our innovative and current patent portfolio is proof of our technological leadership in intuitive motion control systems.

ADVANCING OUR ENVIRONMENTAL, SOCIAL AND GOVERNANCE (ESG)/SUSTAINABILITY JOURNEY

In addition to product and technology expertise, Nexteer continues to demonstrate industry leadership as a business partner and employer of choice through our commitment to corporate social responsibility.

Through these unprecedented times, Nexteer has adapted quickly by strengthening our focus on employee health and safety and acting with a deeper sense of corporate social responsibility – while also learning new ways to operate and move the business forward. We continue to identify opportunities to embrace sustainability in our Strategy for Profitable Growth – such as by aligning our innovation and technology with industry megatrends like electrification and by maintaining our commitment to conduct our business ethically and with transparency.

We believe that through sustainable practices, we can continue to improve our performance and provide greater value to all our stakeholders, including shareholders, employees, customers, suppliers, local communities and society. By incorporating our five key focus areas of sustainability, we have achieved various recognitions, for example, *Newsweek's* list of America's Most Responsible Companies for a third consecutive year, as well as Best Employer awards and Great Place to Work certifications in multiple regions. As we advance our ESG journey, we continue to integrate a sustainability mindset into our global business strategies and culture.

SUSTAINABILITY HIGHLIGHTS FIVE KEY FOCUS AREAS



BUSINESS ETHICS



SUPPLY CHAIN



COMMUNITY



VALUE CREATION



**HEALTH, SAFETY
and ENVIRONMENT**

We publish an annual ESG/Sustainability Report in accordance with the Environmental, Social and Governance Reporting Guide, as set out in Appendix 27 to the Rules Governing the Listing of Securities on The Stock Exchange of Hong Kong Limited (the **Listing Rules**). We invite you to learn more about our culture and the strides we are making to improve our sustainable performance by referencing our Corporate Sustainability information at nexteer.com/sustainability.

Business Overview

DEMONSTRATED LEADERSHIP VIA TECHNOLOGY DEMONSTRATIONS & SPEAKING ENGAGEMENTS

In 2021, Nexteer's industry thought leaders continued to be sought after speakers at high-profile events around the world to discuss the challenges, opportunities and solutions in advanced safety and performance, as well as manufacturing excellence.

Nexteer speakers were featured at the following 2021 events:

- 2021 Reuters Car of the Future CTO Panel
- 2021 American Automotive Summit
- *Automotive News* PACE Innovation Panel
- 2021 ChassisTech Plus
- Automotive ISO26262 Functional Safety Summit
- China Automotive CIO Summit

CUSTOMER AND INDUSTRY RECOGNITION

In 2021, Nexteer was honoured for innovation, quality and excellence – as well as for exceptional customer relationships – as summarised below:

INNOVATION AWARDS

- 2021 *Automotive News* PACEpilot Innovation to Watch for Steer-by-Wire with Stowable Steering Column & CNXMotion Brake-to-Steer
- 2022 CES Innovation Award Honouree for Steer-by-Wire with Stowable Steering Column & Automated Steering Actuator
- China Automobile Industry's Automotive Innovation Technology Award for HO EPS
- China Auto Business Review's Lingxuan Award for mCEPS

SUPPLIER PARTNERSHIP, QUALITY AND MANUFACTURING AWARDS

- GM's of the Year Award – Second Consecutive Year
- 2020 GM Supplier Quality Excellence Award for Nexteer Juarez, Mexico; Nexteer Queretaro, Mexico; Nexteer Bengaluru, India; Nexteer Wuhu, China and Nexteer Chongqing, China
- GM Customer Care & Aftersales' Platinum Status Certificate for Nexteer Suzhou, China
- SAIC GM Aftermarket's Excellent Supplier Award for Nexteer Suzhou, China
- SAIC GM Wuhan's Enterprising Award for Nexteer Wuhu, China
- SAIC GM Dongyue Industry Collaboration & Co-Improvement Award for Nexteer Zhuozhou, China
- ChangAn's Excellent Supplier Award for Nexteer Chongqing, China
- National Association of Manufacturers' 2021 Manufacturing Leadership Award for Enterprise Integration Technology Leadership
- China Automobile & Parts Industry Developing & Innovation Awards' Innovation Capability Award
- Top 20 Fastest Development Industrial Company in Jiangjin District for Nexteer Chongqing, China
- One of the 2020 Outstanding Economic Contribution Enterprises in Suzhou Industrial Park for Nexteer Suzhou, China
- Dongfeng Motor Corporation Passenger Vehicle Company (**DFPV**) Delivery Award for Nexteer Wuhan
- e-GT NEV's Outstanding Delivery Award for Nexteer Liuzhou
- Wuling Automobile Industry' Best Service Award for Nexteer Liuzhou
- Suzhou Quality Award for Nexteer Suzhou
- Chery's Excellent Supplier Award to Nexteer Suzhou
- International Team Excellence Award (**ITEA**)'s Bronze Prize at the American Society of Quality's 2021 World Conference of Quality and Improvement for Nexteer Suzhou, China – Reducing Scrap Project
- Gold Award of QCFI (Quality Circle Forum of India) for Nexteer Pune
- GAC's Excellent Cooperation Award to Nexteer Suzhou

Business Overview

SUSTAINABILITY AND PEOPLE

- *Newsweek's* 2022 List of America's Most Responsible Companies – Third Consecutive Year
- Nexteer Mexico Recognised by Expansion Magazine's "Super Empresas 2021" as One of the Best Places to Work in Mexico
- Manpower Group's Friendly Place to Work for Nexteer Poland
- Forbes 10 Best Automotive Industry Workplaces in Poland for Nexteer Poland
- Great Place to Work® Nexteer Morocco
- Great Place to Work® Nexteer Brazil
- HappyIndex® Trainees
- Top Human Resources Management Award from 51job.com for Nexteer China's excellent work in human resource management
- Most Responsible Company in Suzhou Industrial Park Award for Nexteer China
- Best Employer Greater Suzhou to Nexteer Suzhou
- Outstanding Employer Jiangsu Province to Nexteer Suzhou
- 2021 CSO50 Award from IDG'S CSO for Innovative Cybersecurity Framework

Nexteer not only wins industry awards and recognition, but we also help our customers win awards too – including the **2022 North American Utility of the Year Ford Bronco featuring Nexteer's REPS and Column technologies, plus some of our latest steering innovations.**

- **REPS:** Enables driver-assist features like lane keeping, auto park assist and more – plus it enables over-the-air software flash updates.
- **Modular PowerPack:** it is a compact design, enabled by the first of its kind "double" folded circuit card. The folded board not only improves packaging, but also reduces cost due to the elimination of traditional interconnects between individual stacked boards.
- **10FIT Design:** Enhances safety by utilising backup redundancies in the controller circuits, sensors and software.
- **Advanced Software:** Collaborated with Ford on developing an optimum software package to customise steering performance for an off-road usage profile. The software-driven steering performance complements the personality of the Bronco's off-road character.

REGIONAL MARKET HIGHLIGHTS

In 2021, Nexteer continued optimisation of our global manufacturing footprint and technical centres to enhance efficiencies as well as customer and market responsiveness. Nexteer's global footprint includes 26 manufacturing facilities, three technical centres, one software centre and 13 customer service centres. The following is a brief overview of accomplishments by region during 2021.

North America (NA)

Throughout the year, our NA segment remained focused on executing flawless programme launches and providing exceptional quality and technical support to our customers, as well as winning future business for our USA and Mexico operations.

In 2021, the NA segment executed 11 major programme launches, including columns and REPS on the new Ford Bronco, halfshalls on the Chevrolet Bolt EUV and REPS on the new Jeep Grand Cherokee. With our dedication to launch excellence, Nexteer in Juarez, Mexico and Querétaro, Mexico were both recognised with GM's "Supplier Quality Excellence Award." Nexteer was also recognised with GM's Supplier of the Year Award – for the second consecutive year.

Despite industry challenges, our North America team also recorded new Booking successes with customer programme wins in 2021 totaling US\$4.1 billion – including a breakthrough steering win with a segment leader in the utility and all-terrain vehicle field. These wins represented growth across new and conquest programmes, including securing incumbent programmes for next generation, high-volume vehicles with existing customers.

The collective impact of NA's 2021 programme launches plus carry-over benefit from 2020 launches, enabled the NA segment to achieve a 3.1% increase in revenue when compared with 2020. Adjusting for foreign currency and commodity recoveries, the segment experienced a revenue increase of 1.0%, outperforming the market by 90 basis points.

Beyond fiscal achievements, our innovative technologies were also recognised with several prestigious industry awards. Our SbW with stowable steering column was awarded Automotive News' 2021 PACEpilot Innovation to Watch, which recognises post-pilot, pre-commercial innovations in the automotive and future mobility space that have the potential to revolutionise an automaker's business.

In addition, our SbW with stowable steering column and our automated steering actuator were both honoured with 2022 CES Innovation Awards. This award honours outstanding design and engineering in 27 consumer technology product categories based on innovation, engineering and functionality, aesthetics and design.

In May 2021, Nexteer and our United Auto Workers Local #699 union (**UAW**) partners successfully achieved a new collective bargaining agreement (**Agreement**), following a membership vote that ratified the Agreement. This new mutually competitive Agreement will be in effect through March 2026 and will build a strong, sustainable future for our employees and Nexteer.

Our NA DL business has continued its third year of transforming the manufacturing processes at our Saginaw, USA DL operations in 2021. The transformation initiative included renovation of 15,400 square meters of floorspace, relocation of more than 550 pieces of equipment and implementation of significantly improved process technologies. We expect significant improvements in the overall business performance, including cost, quality and asset utilisation.

Business Overview

Asia Pacific (APAC)

The APAC segment successfully launched 19 programmes in the region, covering international OEMs, local OEMs and key NEV customer projects in 2021. Key programme launches in 2021 included: Columns on the GWM Haval H9, DL on the Mercedes C-Class, Mitsubishi Outlander, Renault Arkana, Nissan Pathfinder and Infiniti QX60 and CEPS on the GAC Aion Y and Chevrolet Bolt EUV. These programme launches, and the carry-over benefit from launches in 2020, enabled the APAC segment to achieve a 26.2% increase in revenue when compared with 2020. Adjusting for foreign currency and commodity recoveries, the segment experienced a revenue increase of 18.4%, outperforming the market by 1,330 basis points.

APAC Bookings in 2021 totaled US\$1.3 billion. In addition to incumbent customer programmes, the segment also conquered several key customer programmes in both EPS and Driveline business, providing further growth opportunities.

Nexteer's JVs in China were also recognised for significant revenue growth. Nexteer's JV with Changan, Chongqing Nexteer Steering Systems, Co., Ltd. was listed in the Top 20 Fastest Development Industrial Company in Jiangjin District, Chongqing and Nexteer's JV with Lingyun, Industrial Corp., Ltd., Nexteer Lingyun Driveline (Wuhu) Co., Ltd. was recognised as China Little Giant Company in Anhui Province.

The APAC segment continued to develop in-region engineering capabilities benefitting current and future customers as well as fostering an innovative culture and environment throughout the organisation. APAC successfully launched mCEPS, a cost-efficient platform design providing advanced safety features for ADAS L2-L5, which will offer additional growth opportunities in the future. In addition to mCEPS, Nexteer announced the launch of its 48-volt iBSG eDrive product with a leading Chinese domestic OEM, with plans for production in the first half of 2022. This launch provides a foundation and entry point for the Company's exploration into additional eDrive applications and customer expansion.

In 2021, APAC continued delivering exceptional quality to our customers. Nexteer Suzhou earned the Bronze Level Winner of the ITEA in the 2021 World Conference on Quality & Improvement, the world's premier quality conference and competition, and received Suzhou Mayor's Quality Award recognising Nexteer's high-quality standards.

The APAC segment also earned a wide range of recognition from customers, government and associations in recognition of innovation, service, CSR activities and positive social impact. These included: Nine customer awards for excellent performance in 2021 from GM, Changan, SGM, Chery Automobile Co. Ltd., Dongfeng Motor Corporation, GAC and e-GT NEV; three awards for being an employer of choice; and three awards from leading trade media recognising Nexteer's capabilities in innovation and products, as well as the establishment of a third Nexteer Library in a rural area in China.

Europe, Middle East, Africa and South America (EMEASA)

In 2021, the EMEASA segment continued its growth and product diversification trend by launching six new programmes across all sites, including BMW iX Power Column, BMW 2-Series Active Tourer SPEPS, CEPS with Fiat Pulse – the SUV of the Year in Brazil, and several high-volume driveline programmes with RNM, the Renault Express and Renault Kangoo. With the 2021 programme launches, EMEASA produces all product lines in the region.

These programme launches, and the carry-over benefit of launches executed in 2020, enabled the EMEASA segment to achieve a 20.6% increase in 2021 revenue when compared with 2020. Adjusting for foreign currency and commodity recoveries, the segment experienced a revenue increase of 16.4%, outperforming the market by 1,890 basis points. We continue to work with European customers such as Stellantis, BMW and RNM to grow our Steering and DL revenue in the region. In addition to successful launches, EMEASA also recorded new Booking successes in 2021 totaling US\$0.5 billion.

EMEASA's growth engine – the newly established Kenitra, Morocco facility – continued its strong trend of high-volume DL launches while also reaching peak volumes for programmes launched in 2019 and 2020. In 2021, the operation focused on enhancing manufacturing efficiencies while navigating significant customer vehicle production schedule changes resulting from global supply chain constraints.

The growth of EMEASA was driven by new programmes and product groups, which are mainly developed in the region, the technical development centre in Tychy, Poland and the Customer Service Centres in Germany, France, Italy and Brazil. Currently, 81% of all design work is performed locally (+71% in 2020). The strengthening of regional engineering is made possible by the on-going expansion of the development team. With the global design responsibility for pinion based EPS systems, EMEASA plays an important role in Nexteer's strategic innovation network.

To support EMEASA's growth, the region broke ground on a new facility to expand its technical capabilities and infrastructure at the Tychy, Poland Technical Centre. This expansion, including advanced testing, validation and training will enable the region to drive efficiencies and customer responsiveness with our engineering and software operations and maintain recognition as a great place to work.

Meanwhile in Brazil, volume recovered strongly in 2021 across CEPS, SPEPS and DL, mainly driven by Stellantis' leading market position. Brazil operations also secured its Great Place to Work certification.

During 2021, EMEASA also earned multiple recognitions related to its OneNexteer culture, including Manpower Group's Friendly Place to Work for Nexteer Poland, Forbes 10 Best Automotive Industry Workplaces in Poland for Nexteer Poland and two Great Place to Work® certifications – one for Nexteer Morocco and one for Nexteer Brazil.

Beyond industry recognition, community outreach, volunteering and social responsibility are also a natural byproducts of a highly engaging employee culture. In 2021, EMEASA demonstrated its commitment to local communities across five countries through almost 3,000 volunteer hours and charity activities.

Financial Highlights

Results (US\$'000)	2021	2020	Change
Revenue	3,358,725	3,032,210	10.8%
Gross profit	363,429	411,376	(11.7%)
Profit before income tax	114,013	114,462	(0.4%)
Income tax benefit (expense)	12,390	7,841	58.0%
Profit attributable to equity holders of the Company	118,440	116,766	1.4%
Profit for the year	126,403	122,303	3.4%
Adjusted EBITDA	360,763	378,012	(4.6%)

Assets and Liabilities (US\$'000)	2021	2020	Change
Non-current assets	1,846,274	1,809,734	2.0%
Current assets	1,360,225	1,496,007	(9.1%)
Non-current liabilities	261,783	277,218	(5.6%)
Current liabilities	942,127	1,107,538	(14.9%)
Capital and reserves attributable to equity holders of the Company	1,954,629	1,882,002	3.9%

These financial highlights should be read in conjunction with the Group's consolidated financial statements for the year ended December 31, 2021 (the **Consolidated Financial Statements**).



***MANAGEMENT
DISCUSSION
& ANALYSIS***

Management Discussion and Analysis

The following management discussion and analysis should be read in conjunction with the Consolidated Financial Statements, included herein, which have been prepared in accordance with IFRS as issued by the International Accounting Standards Board.

FINANCIAL REVIEW

Financial Summary

The Group navigated another challenging year as the residual impacts of the 2020 COVID-19 pandemic continued to place a strain on the automotive industry. Inflationary pressures and volatility in automotive original equipment manufacturer (**OEM**) production schedules, especially during the second half of 2021, pressured the Group's profit margins despite experiencing an increase in revenue when compared with 2020. The Group's revenue increased by 10.8% for the year ended December 31, 2021 compared with 2020, with all three geographical segments positively impacted as OEM vehicle production recovered from the significant adverse operating environment experienced during 2020 as a result of the global pandemic. As reported by IHS Markit Ltd. (January 2022), global OEM vehicle production increased by 2.5% during 2021 when compared with 2020.

Although the Group's 2021 revenue significantly improved compared with last year as highlighted above, our financial performance was tempered by industry-wide headwinds that began to emerge in early 2021 and accelerated through the remainder of the year. These headwinds included, among other factors, global shortages in the supply of various sub-components of raw materials, principally semiconductor chips, rising commodity costs, dramatic increases in transportation and logistics costs and continued impacts from the health crisis in various countries in which the Group operates in or is served by its established supply chain partners. These headwinds resulted in many OEM's needing to quickly and significantly adjust or suspend vehicle production during 2021, with the second half of the year being the most impacted. The Group's North America, Europe and South America OEM customers were the most impacted by these factors which adversely impacted the financial performance of the Group's North America and EMEASA segments. The lapse of government funding support in some key areas, notably the lapse of a major employment tax credit in the US as well as an engineering-related subsidy from the Chinese government, also contributed to increased costs during 2021. Compared with the year ended December 31, 2020, full-year 2021 gross profit of US\$363.4 million decreased by 11.7%; profit before income tax of US\$114.0 million decreased by 0.4%; profit attributable to equity holders of the Company of US\$118.4 million improved by 1.4%; and Adjusted EBITDA of US\$360.8 million decreased by 4.6%.

The Group recorded an income tax benefit of US\$12.4 million for the year ended December 31, 2021, US\$4.6 million higher when compared with 2020. The increased benefit was a result of preferential tax rates and tax holidays mainly in China and Poland, offset by withholding taxes due to finalising an audit. In both 2020 and 2021, income tax benefits reflect the carryback of a US pre-tax loss generated during the period to prior tax years as provided for under the provisions of the US Coronavirus Aid, Relief, and Economic Security (**CARES**) Act, which was enacted in March 2020 to provide economic support to enterprises as result of the COVID-19 pandemic.

For the year ended December 31, 2021, the Group's net cash generated from operating activities was US\$287.4 million, a decrease of US\$132.4 million compared with US\$419.8 million for the year ended December 31, 2020. Despite slightly higher net earnings, the decrease in cash flows from operating activities was primarily attributable to higher working capital investment, increased inventory levels resulting from semiconductor shortages and other commodity constraints and extended logistics and transportation schedules experienced during 2021 when compared with 2020.

The cash from operating activities less cash used in investing activities was positive US\$1.7 million for 2021, a decrease of US\$130.1 million, compared with US\$131.8 million for the year ended December 31, 2020. The decrease in cash flow along with the decrease in net debt driven by the early redemption and pay-off of the US\$250.0 million 5.875% senior notes due 2021 (**Notes**) in April 2021, offset by net borrowings of US\$85.0 million under the Group's US revolving credit facility, resulted in a lower ending cash balance of US\$326.5 million as at December 31, 2021 compared with US\$553.4 million as at December 31, 2020.

Management Discussion and Analysis

A summary comparison of the Group's financial performance for the first half of 2021 compared with the second half of 2021 for selected metrics is provided in the table below:

Results (US\$'000)	H1 2021	H2 2021	Change
Revenue	1,734,394	1,624,331	(6.3%)
Gross profit	226,472	136,957	(39.5%)
Gross profit margin (as % of revenue)	13.1%	8.4%	(4.7%)
Profit attributable to equity holders	83,143	35,297	(57.5%)
Profit margin (as % of revenue)	4.8%	2.2%	(2.6%)
EBITDA	212,890	147,873	(30.5%)
EBITDA margin (as % of revenue)	12.3%	9.1%	(3.2%)
Net (decrease) increase in cash and cash equivalents	(225,223)	(1,684)	(99.3%)

Operating Environment

The global automotive market has a direct impact on our business and operating results. Factors affecting the industry include macro-economic influences such as consumer confidence, fluctuations in commodity prices, currency, fuel prices and regulatory environments. The ability to secure material and components from our supply-base is also critical, as evidenced by the semiconductor chip shortage which provided a significant industry-wide challenge in 2021. The Company operates primarily in the US, Mexico, China, Poland, India, Morocco and Brazil.

Global OEM light vehicle production rebounded significantly during 2021 when compared with 2020 as a result of the COVID-19 pandemic's impact on the first half of 2020. OEM light vehicle production was most heavily impacted in the second quarter of 2020 as North America, Europe and South America OEM and supplier manufacturing operations were impacted by government mandated shutdowns from mid-March through the latter part of May of 2020.

According to IHS Markit Ltd. (January 2022), global OEM light vehicle production for the year ended December 31, 2021 increased by 2.5% compared to the year ended December 31, 2020; although OEM vehicle production across all major regions served by the Group significantly decelerated in the second half of 2021, reflecting industry-wide supply shortages and logistics and transportation constraints, resulting in a year-over-year decline of 16.0% in global OEM light vehicle production when compared with the same period in 2020. The change in OEM light vehicle production for the first half, second half and year ended December 31, 2021 compared with the same periods in 2020 for key markets served by the Group is provided in the table below:

	H1 2021	H2 2021	Full-Year 2021
North America	32%	(21%)	0.1%
China	25%	(10%)	4.0%
India	83%	(8%)	25%
Europe	28%	(29%)	(5.0%)
South America	62%	(10%)	16.1%

The Group conducts its business from a global operating footprint to service its broad customer base and, accordingly, the financial results of the business are impacted by changes in foreign currencies measured against the US dollar, principally the European euro (**Euro**) and the Chinese renminbi (**RMB**). The Group's financial results were also favourably impacted by foreign currency translation as the US dollar weakened against both the Euro and RMB during 2021 compared with a year ago.

During the year ended December 31, 2021, the Group successfully launched 36 new customer programmes – 19 programmes in Asia Pacific, 6 programmes in EMEASA and 11 programmes in North America. Of the 36 customer programme launches, 32 represented new conquest business for the Group, 4 represented incumbent business and 15 represented EV programmes.

Management Discussion and Analysis

Revenue

The Group's revenue for the year ended December 31, 2021 was US\$3,358.7 million, an increase of US\$326.5 million, or 10.8%, compared with US\$3,032.2 million for the year ended December 31, 2020. As highlighted in the preceding narrative, the recovery in OEM light vehicle production across all geographic markets served by the Group was the principal factor driving significantly higher revenue for the year ended December 31, 2021 when compared with 2020. Foreign currency translation further improved the Group's revenue by approximately US\$56.7 million, principally impacting the Asia Pacific and EMEASA segments, given the weakening of the US dollar against the RMB and EURO during 2021 compared with a year ago. Customer recoveries, principally resulting from the pass through of raw material commodity increases, further increased revenue during 2021 by about US\$52.6 million. Adjusting for favourable foreign currency translation and customer commodity recoveries, Nexteer's revenue rose by 7.2% in 2021 compared with a year ago, outperforming the revenue increase in OEM production for served markets by 470 basis points. This performance reflected the on-going benefit from the launch of new and conquest customer programmes in both 2021 and 2020 and favourable vehicle mix.

We measure the results of our operations by geographic segment regions. The change in revenue is analysed by volume, mix, price and foreign currency translation impact. Volume measure changes are driven by the volume of products sold and mix changes are driven by the type of products sold. Price measures the impact of changes within the pricing structure of each product sold. The impact of foreign currency translation is measured by the changes in foreign currencies measured against the US dollar.

Revenue by Geographical Segments

The following table sets forth revenue by geographic segments for the years indicated:

	For the year ended December 31, 2021		For the year ended December 31, 2020	
	US\$'000	%	US\$'000	%
North America	1,963,723	58.5	1,905,132	62.8
Asia Pacific	809,489	24.1	641,429	21.2
EMEASA	585,513	17.4	485,649	16.0
Total	3,358,725	100.0	3,032,210	100.0

The changes in revenue by geographical segments are primarily due to the following:

- North America segment – Revenue increased by US\$58.6 million, or 3.1%, for the year ended December 31, 2021 compared to the year ended December 31, 2020. The most significant factor contributing to the increase in revenue was an improved OEM demand environment, with North America OEM light vehicle production and full-size truck production for 2021 increasing by 0.1% and 12.4%, respectively, compared with the same period in 2020, which was partially offset by customer pricing and a Columns programme transition in the first half of 2020. Customer recoveries, principally the pass through of commodities inflation, further increased revenue by about US\$38.7 million in 2021 compared to 2020. Adjusting for foreign currency translation and customer commodity recoveries, North America adjusted revenue increased by 1.0% compared to the change in OEM customer production of 0.1%, outperforming the market by 90 basis points.

Management Discussion and Analysis

- Asia Pacific segment – Revenue increased by US\$168.1 million, or 26.2%, for the year ended December 31, 2021 compared to the year ended December 31, 2020. The most significant factor contributing to the revenue increase was higher OEM light vehicle production, with total Asia Pacific OEM production volumes higher by 5.1%, and China and India OEM production volumes higher by 4.0% and 25.0%, respectively, for the year ended December 31, 2021 compared with 2020. In addition to the improvement in the demand environment, the segment continued to benefit from new and carry-over revenue from new and conquest customer programme launches. Favourable foreign currency translation provided a further benefit of US\$43.5 million as the US dollar weakened against the RMB during 2021 compared with 2020. Adjusting for foreign currency translation and customer commodity recoveries, Asia Pacific adjusted revenue increased by 18.4% compared to the change in OEM customer production of 5.1%, outperforming the market by 1,330 basis points.
- EMEASA segment – Revenue increased by US\$99.9 million, or 20.6%, for the year ended December 31, 2021 when compared with the year ended December 31, 2020. Although OEM light vehicle production in the EMEASA segment fell by 2.5% during the year ended December 31, 2021 compared with 2020, the biggest contributor to the Group's increased revenue in the segment was the increase in South America OEM light vehicle production of 16.1%, tempered by a decrease in European OEM production of 5.0%. The segment also benefited from on-going customer programme growth in the segment's Morocco manufacturing facility, which began production in 2019, which increased revenue by US\$47.4 million compared with a year ago. Favourable foreign currency translation provided a benefit of US\$13.2 million as the US dollar weakened against the Euro during the year ended December 31, 2021 compared with 2020. Adjusting for foreign currency translation and customer commodity recoveries, EMEASA adjusted revenue increased by 16.4% compared to the change in OEM customer production of -2.5%, outperforming the market by 1,890 basis points.

Revenue by Products

The following table sets forth the Group's revenue by product lines for the years indicated:

	For the year ended December 31, 2021		For the year ended December 31, 2020	
	US\$'000	%	US\$'000	%
EPS	2,325,502	69.2	2,058,184	67.9
CIS	317,786	9.5	343,521	11.3
HPS	136,948	4.1	120,020	4.0
DL	578,489	17.2	510,485	16.8
	3,358,725	100.0	3,032,210	100.0

The Group experienced an increase in EPS revenue of US\$267.3 million, or 13.0%, for the year ended December 31, 2021 compared with 2020, largely reflecting increased OEM light vehicle production volumes across all segments. EPS revenue was also bolstered by the launch of 11 customer programmes in 2021, including 8 new business launches in Asia Pacific and North America. CIS revenue decreased by US\$25.7 million, or 7.5% for the year ended December 31, 2021 compared with a year ago, primarily driven by a North America customer programme transition which was completed in the first half of 2020 which impacted the comparison by approximately US\$21.0 million. HPS revenue increased by US\$16.9 million, or 14.1%, for the year ended December 31, 2021 compared with 2020. DL revenue increased by US\$68.0 million, or 13.3%, for the year ended December 31, 2021 compared with last year, as a result of higher OEM light vehicle production and significant revenue from 18 new and carry-over customer programme launches primarily in China, India and Morocco.

Management Discussion and Analysis

Net Profit Attributable to Equity Holders

The Group's net profit attributable to equity holders of the Company for the year ended December 31, 2021 was US\$118.4 million or 3.5% of total revenue, an increase of US\$1.6 million, or 1.4%, compared to US\$116.8 million, or 3.9% of total revenue for the year ended December 31, 2020. The increase was principally attributable to the following factors:

- The recovery of OEM light vehicle production across all regions served by the Group for the year ended December 31, 2021, following the adverse impact of the COVID-19 pandemic in 2020.
- The favourable earnings impact from the recovery in OEM light vehicle production, was primarily offset by several factors which impacted the automotive industry broadly including raw material commodity inflation, significant increases in transportation and logistics costs, operating inefficiencies arising from increasing supply chain constraints, most notably semiconductor chip shortages, which negatively impacted OEM vehicle production schedules during 2021 when compared with 2020.
- Profit before income taxes for the year ended December 31, 2021 also benefited from the non-recurrence of a product development intangible asset impairment of US\$34.1 million related to customer programme cancellations and lower volume production expectations for specific programmes which was recognised in 2020 compared to net impairment reversals of US\$7.2 million in 2021 related to recoveries received from customers for impairments recognised in prior years.

Cost of Sales

The Group's cost of sales for the year ended December 31, 2021 was US\$2,995.3 million, an increase of US\$374.5 million, or 14.3%, from US\$2,620.8 million for the year ended December 31, 2020.

Raw material costs represent a significant portion of the Group's total cost of sales and for the year ended December 31, 2021 totaled US\$2,101.4 million, or 62.6% of revenue, compared with US\$1,823.5 million, or 60.1% of revenue, for 2020, reflecting an increase of US\$277.9 million, or 15.2%. The increase in raw material costs was principally attributable to the increase in revenue for 2021 when compared with a year ago. Factors contributing to the increase in raw materials as a percent of revenue include commodity inflation, elevated logistics and transportation costs of inbound material, and lower annual supplier productivity gains resulting from increasing supply chain pressures experienced in 2021 compared with the prior year.

Depreciation and amortisation, including amortisation of capitalised product development costs, charged to cost of sales for the year ended December 31, 2021 was US\$230.4 million, an increase of US\$22.5 million, or 10.8% from US\$207.9 million for the year ended December 31, 2020.

Amortisation of capitalised product development costs recorded as cost of sales amounted to US\$104.0 million for the year ended December 31, 2021, representing 3.1% of revenue, an increase of US\$13.5 million, or 14.9%, from US\$90.5 million, representing 3.0% of revenue, for the year ended December 31, 2020. We expect amortisation to continue to increase in future years with the launch of new customer programmes that are currently in development.

Excluding raw material costs and depreciation and amortisation and fixed and intangible asset impairments, remaining manufacturing costs of US\$663.5 million, or 19.8% of revenue for the year ended December 31, 2021 were higher by US\$70.6 million, or 11.9%, when compared with US\$592.9 million, or 19.6% of revenue, for one year ago, which was directly attributable to the increase in production for the year ended December 31, 2021. The Group also experienced significant increases in outbound logistics and transportation costs during 2021 related to both demand pressures and increased expedition of raw materials as a result of supply chain constraints. As a percent of revenue, cost of sales increased to 89.2% for the year ended December 31, 2021 compared with 86.4% a year ago.

Gross Profit

The Group's gross profit for the year ended December 31, 2021 was US\$363.4 million, a decrease of US\$48.0 million, or 11.7%, from US\$411.4 million for the year ended December 31, 2020. Gross profit margin for the year ended December 31, 2021 was 10.8% compared with 13.6% for the year ended December 31, 2020. The decrease in gross profit was attributable to inflationary pressures and operational inefficiencies resulting from industry volatility during 2021, as outlined in the preceding cost of sales narrative.

Management Discussion and Analysis

Engineering and Product Development Costs

For the year ended December 31, 2021, the Group's engineering and product development costs charged to the income statement were US\$116.3 million, representing 3.5% of revenue, a decrease of US\$37.3 million, or 24.3%, as compared to US\$153.6 million, or 5.1% of revenue for the year ended December 31, 2020. The Group recognised a net reversal of product development intangible asset impairment of US\$7.2 million in 2021. The Group recorded a customer recovery from a previously impaired programme of US\$8.7 million, with US\$5.3 million recorded in the North America segment and US\$3.4 million recorded in the EMEASA segment, partially offset by the Group recording impairment of US\$1.5 million related to programme cancellations and declining volumes in the Asia Pacific segment and the North America segment in the amount of US\$0.5 million and US\$1.0 million, respectively. For the year ended December 31, 2020, the Group recognised product development intangible asset impairments of US\$34.1 million related to customer programme cancellations and lower volume production expectations for specific programmes. The impairments were recorded as engineering and product development costs in the Asia Pacific segment and the North America segment in the amount of US\$5.1 million and US\$29.0 million, respectively. The intangible asset impairments recorded in the North America segment were a result of the Group's US domiciled intellectual property holdings arrangement.

Capitalised interest related to engineering development costs totalled US\$9.7 million for the year ended December 31, 2021 and US\$16.3 million for the year ended December 31, 2020. Depreciation and amortisation charged to engineering and product development costs for the year ended December 31, 2021 was US\$12.0 million, an increase of US\$1.1 million, or 9.7%, from US\$10.9 million for the year ended December 31, 2020.

The Group's aggregate investment in engineering and product development costs is defined as the sum of costs charged to the consolidated income statement (excluding impairment charges associated with costs capitalised in prior periods) and total costs capitalised as intangible assets during the current period which will be amortised in future periods upon launch and start of production of related customer programmes currently in development. For the year ended December 31, 2021, the Group incurred an aggregate investment in engineering and product development costs of US\$271.2 million, a decrease of US\$2.5 million, or 0.9%, compared with US\$273.7 million for the year ended December 31, 2020, reflecting cost actions taken to temper the earnings impact of a lower revenue environment.

Selling, Distribution and Administrative Expenses

The Group's selling, distribution and administrative expenses for the year ended December 31, 2021 were US\$149.1 million, representing 4.4% of revenue, an increase of US\$19.6 million, or 15.1%, as compared to US\$129.5 million, or 4.3% of revenue, for the year ended December 31, 2020. The increase in selling, distribution and general and administrative expense is attributable to several factors, including the lapse of a US employment tax credit of US\$9.1 million, and increasing costs related to employee compensation plans and general corporate insurance coverages of US\$4.2 million and US\$3.0 million, respectively. Depreciation and amortisation charged to administrative expense for the year ended December 31, 2021 was US\$10.3 million, an increase of US\$0.5 million, or 5.8%, from US\$9.8 million for the year ended December 31, 2020.

Other Gains (Losses), net

Other gains (losses), net represents gains attributable to foreign exchange transactions, losses on disposal of property, plant and equipment and others. Other gains (losses), net for the year ended December 31, 2021 was a gain of US\$17.1 million, an increase of US\$26.6 million compared to a loss of US\$9.5 million for the year ended December 31, 2020. The increase was principally attributable to favourable foreign exchange and lower losses related to the disposal of property, plant and equipment, particularly in the Group's US DL business.

Finance Income/Finance Costs

Finance costs, net, consist of interest income and expense reduced by interest capitalised on qualifying assets and product development. The Group's net finance costs for the year ended December 31, 2021 were US\$1.9 million, a decrease of US\$3.2 million, or 63.3%, as compared to US\$5.1 million from the year ended December 31, 2020. The early redemption of the Group's outstanding US Notes in the amount of \$250.0 million, partially offset by net borrowings on the Company's US revolving credit facility, led to a significant reduction in finance costs during the year ended December 31, 2021, when compared with the same period of 2020.

Management Discussion and Analysis

Share of Results of Joint Ventures

Share of results of joint ventures relates to the Group's investments in Chongqing Nexteer Steering Systems Co., Ltd. (**Chongqing Nexteer**), Dongfeng Nexteer Steering Systems (Wuhan) Co., Ltd. (**Dongfeng Nexteer**) and CNXMotion. For the year ended December 31, 2021, the Group's share of results of joint ventures amounted to US\$3.7 million, US\$0.0 million and (US\$3.0 million) related to Chongqing Nexteer, Dongfeng Nexteer and CNXMotion, respectively (year ended December 31, 2020: US\$3.1 million, (US\$0.3 million) and (US\$2.0 million). Chongqing Nexteer's profitability during the year ended December 31, 2021 was flat when compared with 2020. Dongfeng Nexteer was formed during 2017 and while production began during 2019, the joint venture has yet to achieve a level of customer production to offset the current cost structure and investment for the year ended December 31, 2021. CNXMotion is a research and development (**R&D**) entity focused on integrating lateral and longitudinal controls for mixed mode and AD applications. As an R&D entity, CNXMotion is not anticipated to generate direct revenue for the foreseeable future, but rather benefit the Company from the development and transfer of R&D that may be commercialised and used in the manufacture of future products.

Income Tax Benefit

The Group's income tax benefit was US\$12.4 million for the year ended December 31, 2021, representing 10.9% of the Group's profit before income tax, compared with an income tax benefit of US\$7.8 million, or 6.9% of profit before income tax, for the year ended December 31, 2020. The increased tax benefit was primarily the result of changes in the mix of income generated by US and non-US operations and an increased benefit due to preferential tax rates for tax holidays, mainly China and Poland. Income tax in 2021 and 2020 include tax benefits of \$6.8 million and \$9.8 million, respectively, resulting from US taxable losses available for carryback to prior years at a tax rate of 35% compared to the current statutory rate of 21%. In addition, during the year ended December 31, 2021, the Group reached final agreement with a taxing authority that certain dividends declared and paid by a subsidiary of the Group were subject to withholding tax under the tax law at the time such dividends were paid in the amount of US\$2.4 million.

The CARES Act was passed by US Congress and signed into law on March 27, 2020. The CARES Act provided for a carryback of any net operating loss (**NOL**) arising in a taxable year beginning after December 31, 2017, and before January 1, 2021, to each of the five taxable years preceding the taxable year in which the loss arises (**Carryback Period**). As a result of this provision, taxpayers take into account such NOLs in the earliest taxable year in the Carryback Period, carrying forward unused amounts to each succeeding taxable year. The Company has applied this provision to its tax calculation for the US tax NOL in year 2020 and recognised a benefit for the NOL carryback for both years ended December 31, 2020 and December 31, 2021.

Provisions

As at December 31, 2021, the Group had provisions for litigation, environmental liabilities, warranties and decommissioning of US\$78.0 million, a decrease of US\$0.1 million as compared to US\$78.1 million as at December 31, 2020. The decrease in provisions was principally due to the net change in warranty reserves reflecting US\$14.8 million in cash payments on historical warranty provisions and net additions of US\$14.4 million during 2021.

Liquidity and Capital Resources

Cash Flows

Our business requires a significant amount of working capital, which is primarily used to finance the purchase of raw materials, capital spending for customer programmes and engineering and product development costs. We have historically met our working capital and other capital requirements principally from cash generated from operations and borrowings from third-party financial institutions. We utilise a combination of strategies, including intercompany dividends, intercompany loan structures and other distributions and advances to provide the funds necessary to meet our global liquidity needs. The Company utilises a global cash pooling arrangement to consolidate and manage our global cash balances, which improves cash management efficiency. We believe that cash on hand and availability of borrowings under the Group's existing credit facilities will be adequate to fund our operations.

Management Discussion and Analysis

The following table sets forth a condensed consolidated statement of cash flows for the Group for the years indicated:

	For the year ended December 31, 2021 US\$'000	For the year ended December 31, 2020 US\$'000
Cash (used in) generated from:		
Operating activities	287,383	419,845
Investing activities	(285,664)	(288,002)
Financing activities	(215,448)	(186,943)
Net decrease in cash and cash equivalents	(213,729)	(55,100)

Cash Flows Generated from Operating Activities

For the year ended December 31, 2021, the Group's net cash generated from operating activities was US\$287.4 million, a decrease of US\$132.4 million compared with US\$419.8 million for the year ended December 31, 2020. Despite slightly higher net earnings, the decrease in cash flows from operating activities was primarily attributable to higher working capital investment, including increased inventory levels resulting from semiconductor shortages and other commodity constraints and extended logistics and transportation schedules experienced during 2021 when compared with 2020.

Cash Flows Used in Investing Activities

The Group's cash flows used in investing activities primarily reflect capital spending for purchases of machinery, equipment and tooling and capitalised engineering and product development costs as intangible assets to support customer programmes.

The following table sets forth the cash used in investing activities within the Group for the years indicated:

	For the year ended December 31, 2021 US\$'000	For the year ended December 31, 2020 US\$'000
Purchase of property, plant and equipment	(141,601)	(149,741)
Addition of intangible assets	(146,679)	(137,734)
Other	2,616	(527)
Net cash used in investing activities	(285,664)	(288,002)

Cash Flows Used in Financing Activities

For the year ended December 31, 2021, the Group's net cash flow used in financing activities was US\$215.4 million, an increase of US\$28.5 million compared with US\$186.9 million for the year ended December 31, 2020. The principal driver of the increase in net cash used in financing activities was the early redemption of the Group's outstanding US Notes of US\$250.0 million in April 2021, partially offset by net borrowings on the Company's US revolving credit facility of US\$85.0 million. Net cash flows used in (provided by) financing activities for 2021 included the net repayment of borrowings of US\$164.5 million, repayments of lease liabilities of US\$13.7 million, finance costs paid of US\$15.5 million, dividends paid to shareholders of the Company of US\$23.6 million and proceeds from the exercise of share options of (US\$1.8 million).

Management Discussion and Analysis

Indebtedness

As at December 31, 2021, the Group's total borrowings was US\$84.4 million, a decrease of US\$164.2 million from US\$248.6 million as at December 31, 2020. This decrease was primarily due to the early redemption of the Group's outstanding US Notes of US\$250.0 million, partially offset by net borrowings on the Company's US revolving credit facility.

The following table sets forth the balances of short and long-term borrowing obligations within the Group for the years indicated:

	December 31, 2021 US\$'000	December 31, 2020 US\$'000
Current borrowings	84,403	248,636
Total borrowings	84,403	248,636

The table below sets forth the maturity profile of borrowings within the Group for the years indicated:

	For the year ended December 31, 2021 US\$'000	For the year ended December 31, 2020 US\$'000
Within 1 year	84,403	248,636
Total borrowings	84,403	248,636

Details of the borrowings of the Group during the year are set out in note 16 to the Consolidated Financial Statements.

Pledge of Assets

The Group has several secured borrowings at certain subsidiaries. Assets securing the borrowings differ by site and include accounts receivable, inventories, property, plant and equipment. As at December 31, 2021, the Group had approximately US\$813.4 million total assets pledged as collateral, a decrease of US\$52.8 million as compared with US\$866.2 million as at December 31, 2020. The decrease in collateral pledged was directly related to decreases in the balances of the underlying assets pledged. No significant changes in collateral arrangements have occurred from December 31, 2020 to December 31, 2021.

Exposure to Currency Rate Fluctuations and Related Hedges

The Group seeks to limit its foreign currency exposure through matching its purchase of materials and sale of finished goods in the same currencies subject to sourcing constraints. The Group monitors its remaining foreign currency exposure regularly to reduce the risk of foreign currency fluctuations in its operations.

Gearing Ratio

The Group monitors capital structure on the basis of the gearing ratio. The gearing ratio is calculated as total borrowings divided by total equity at the end of the respective year.

The gearing ratio as at December 31, 2021 was 4.2%, a decrease of 870 basis points as compared to 12.9% as at December 31, 2020. The gearing ratio improved as a result of slightly improved net earnings during the year ended December 31, 2021 and lower borrowings as at December 31, 2021.

Management Discussion and Analysis

COVID-19 and Related Factors Impacting Operations and Financial Performance

Throughout 2020, the COVID-19 pandemic materially impacted the Group's business and results of operations. During the first quarter of 2020, the impact of COVID-19 was initially experienced primarily by operations in China. Following the declaration of COVID-19 as a global pandemic on March 11, 2020, government authorities around the world began to impose shelter-in-place orders and other restrictions. As a result, many OEMs began suspending manufacturing operations, particularly in North America and Europe. This led to various temporary closures of, or reduced operations at, the Group's manufacturing facilities, late in the first quarter of 2020 and throughout the second quarter of 2020. During the second half of 2020, as the global management of COVID-19 evolved and government restrictions were removed or lessened, production levels improved, and substantially all of the Group's production facilities resumed closer to normal operations by the third quarter of 2020.

The global automotive industry continued to be impacted by the COVID-19 pandemic throughout 2021, particularly a result of supply shortages as OEM production demand continued to recover. The most significant supply shortage related to semiconductor chips, which impacted global industry production, resulting in significant cancellations of planned OEM vehicle production during the year. Supply shortages and the on-going volatility in OEM production schedules adversely impacted our manufacturing and material efficiencies in 2021. In addition, increases in certain commodity and logistics and transportation costs had an adverse impact on our operating results for the year ended December 31, 2021. While countries across the globe continue to roll-out vaccination and other health protocols to stem the on-going COVID-19 pandemic, new virus variants have emerged, and it is possible variants could continue to emerge resulting in continued adverse impacts in the future. Management cannot reasonably estimate the full impact the COVID-19 pandemic could have on the Group's financial condition, results of operations or cash flows in the future.

OTHER INFORMATION

Future Prospects

The Group strives to maintain a market-leading position in global advanced steering and driveline systems, including electrification, driver-assist and ADAS-enabling technologies. We boost our current position and future prospects by leveraging the following five Nexteer differentiators:

1. Relentless innovation
2. Depth and breadth of our product portfolio
3. Systems integration experience
4. In-house ownership of R&D and integrated product and process development
5. Global manufacturing footprint and prowess

Megatrends influencing the automotive industry and adjacent sectors, such as LMD, continue to present new and unique channels for Nexteer. We retain thoughtful alignment across our product lines with megatrends including ADAS – Advanced Safety & Performance, Software, Electrification, MaaS and Connectivity. In many cases, our technologies create a natural fit for Nexteer to offer solutions to OEMs across these megatrends, which provides us a competitive advantage and positions us well for potential future opportunities as these megatrends continue to evolve and mature.

Please refer to the Business Overview section earlier in this report for more details on our alignment to these megatrends.

Management Discussion and Analysis

Employees and Remuneration Policy

As at December 31, 2021, the Group had approximately 11,900 full-time employees. The Group's remuneration policies are formulated based on the performance of individual employees and the Company's performance and are reviewed regularly. Our full-time employees participate in various employee benefit plans including retirement benefits, extended disability benefits and workers' compensation. In addition, we have adopted employee incentive plans designed to attract, retain, motivate and encourage employees to commit to enhancing value for us and our shareholders as a whole. For example, the Group has retention programmes that include individual development plans, merit wage adjustments, annual incentive plans and promotions. We offer training programmes to our full-time employees and contract personnel which are designed to develop the skills that we need to meet our enterprise goals and customer requirements and to meet certain training requirements such as mandated customer or regulatory requirements and contractual obligations.

The Group also uses contract personnel to support the workload of the business where considered the most efficient. As at December 31, 2021, we had approximately 1,100 personnel engaged on a contract basis.

FORWARD-LOOKING STATEMENTS

Any forward-looking statements and opinions contained within this Annual Report are based on current plans, estimates and projections, and therefore involve risks and uncertainties. Actual results may differ materially from expectations discussed in such forward-looking statements and opinions. The Company, the Directors and the employees of the Company assume (a) no obligation to correct or update the forward-looking statements or opinions contained in this Annual Report; and (b) no liability in the event that any of the forward-looking statements or opinions do not materialise or turn out to be incorrect.

Directors and Senior Management

DIRECTORS

The Board is responsible and has general powers for the management and conduct of our business. The following table sets out certain information concerning the Directors of the Company (the **Directors**) during the year ended December 31, 2021 and as at the date of this annual report:

Name	Age	Position title	Date of appointment(s)	Roles and responsibilities
Executive Directors				
ZHAO, Guibin (趙桂斌)	57	Executive Director, Chief Executive Officer and Vice Chairman	June 15, 2013, June 2012 and June 3, 2019 (formerly Chairman on June 15, 2013), respectively	Overseeing our Group's strategic vision, direction and goals and overseeing the overall execution of our Group's strategy
MILAVEC, Robin Zane ⁽¹⁾	54	Executive Director and President, Chief Technology Officer & Chief Strategy Officer	June 30, 2020, August 17, 2021 (formerly Senior Vice President on July 1, 2019) and July 1, 2019, respectively	Responsible for integrating corporate strategy, Global Engineering
FAN, Yi (樊毅)	55	Executive Director, Vice President and Company Secretary	August 21, 2012, November 14, 2013 and October 19, 2018, respectively	Managing our Group's operations and handling of company secretarial duties
Non-Executive Directors				
WANG, Jian (王堅) ⁽²⁾	60	Non-Executive Director	June 3, 2019	As a non-Executive Director
LIU, Ping (劉平) ⁽³⁾	53	Non-Executive Director	June 3, 2019	As a non-Executive Director
ZHANG, Wendong (張文冬)	45	Non-Executive Director	November 13, 2020	As a non-Executive Director
LEI, Zili (雷自力) ⁽⁴⁾	51	Chairman and Non-Executive Director	March 16, 2022 and June 8, 2021, respectively	As a non-Executive Director
Independent Non-Executive Directors				
LIU, Jianjun (劉健君)	53	Independent non-Executive Director	June 15, 2013	As an Independent non-Executive Director
WEI, Kevin Cheng (蔚成)	54	Independent non-Executive Director	June 15, 2013	As an Independent non-Executive Director
YICK, Wing Fat Simon (易永發)	63	Independent non-Executive Director	August 15, 2017	As an Independent non-Executive Director

Notes:

- (1) Mr. MILAVEC, Robin Zane, an Executive Director, was appointed as President of the Company with effect from August 17, 2021.
- (2) Mr. WANG, Jian (王堅), has resigned as Chairman of the Board and been appointed as a member of the Audit and Compliance Committee with effect from March 16, 2022. He remains as a non-Executive Director.
- (3) Mr. LIU, Ping (劉平), has retired as a non-Executive Director and ceased to be a member of the Audit and Compliance Committee of the Board due to personal work adjustment with effect from June 8, 2021.
- (4) Mr. LEI, Zili (雷自力), was appointed as a non-Executive Director and a member of the Audit and Compliance Committee with effect from June 8, 2021. Mr. LEI was appointed as Chairman of the Board and ceased to be a member of the Audit and Compliance Committee with effect from March 16, 2022.

Directors and Senior Management

Executive Directors

ZHAO, Guibin (趙桂斌) (Vice Chairman and Chief Executive Officer), aged 57, was appointed as our Executive Director on June 15, 2013 and has successively acted as Chairman of the Board from June 15, 2013 and as Vice Chairman from June 3, 2019. Mr. ZHAO has also been our Chief Executive Officer since June 2012. Mr. ZHAO has over 20 years of relevant experience in the automotive industry. As the Vice Chairman of the Board, Mr. ZHAO is primarily responsible for assisting the Chairman to arrange and convene shareholder and Board meetings, supervising the implementation of the relevant resolutions and acting on behalf of the Chairman upon delegation by the Chairman or when the Chairman is incapable to act. As the Chief Executive Officer, he is primarily responsible for leading Nexteer's Global Strategy Council (**GSC**), setting our strategic vision, direction and goals and overseeing the overall execution of our Group's strategy. He sets the strategic direction of the Company, acts as a "bridge" between senior management and the Board, is responsible for the Company's new product lines and advanced engineering (business development), joint ventures and M&A activities, maintains relationships with major external stakeholders, chooses and manages the senior management team, determines overall incentive compensation targets and communicates internally. Mr. ZHAO is also the chief executive officer and the chairman of the board of directors of Nexteer Automotive Corporation, one of our indirectly wholly-owned subsidiaries. He held the position as deputy chief economist of Aviation Industry Corporation of China, Ltd. (**AVIC**), our controlling shareholder (as defined in the Rules Governing the Listing of Securities on The Stock Exchange of Hong Kong Limited (the **Hong Kong Stock Exchange**)), from February 2010 to June 2016. He held the positions as general manager and chairman of the board of directors of AVIC Automotive Systems Holding Co., Ltd. (**AVIC Auto**), a subsidiary of AVIC, our controlling shareholder, from 2009 to October 2018. Mr. ZHAO had been the chairman of the board of directors of Pacific Century Motors, Inc. (**PCM China**), our controlling shareholder, from December 2010 to February 2019 and was the president of PCM China from February 2019 to November 2020. From August 2016 to November 2019, Mr. ZHAO has been chairman of the board of directors of AVIC Hande (Beijing) Investment Holding Co., Ltd. and Henniges Automotive Holdings, Inc., both of which are non wholly-owned subsidiaries of AVIC Auto. From December 2015 to March 2017, Mr. ZHAO had been a director of AVIC Capital Co., Ltd., a non wholly-owned subsidiary of AVIC, a company listed on the Shanghai Stock Exchange (stock code: 600705). From April 2010 to April 2013, Mr. ZHAO was the chairman of the board of directors of AVIC Heavy Machinery Co. Ltd., a non wholly-owned subsidiary of AVIC, and a company listed on the Shanghai Stock Exchange (stock code: 600765). From 1997 to 2003, Mr. ZHAO was the general manager of Sichuan Lingfeng Aeronautics Hydraulic Machinery Co., Ltd., a wholly-owned subsidiary of AVIC, where he was in charge of corporate governance and operational management. He held the positions as general manager, director and chairman of AVIC Chengdu Engine (Group) Co., Ltd., a wholly-owned subsidiary of AVIC, and as a director and the chairman of the board of its non wholly-owned subsidiary, Sichuan Chengfa Aero Science and Technology Co., Ltd., a company listed on the Shanghai Stock Exchange (stock code: 600391) from August 2003 to January 2009. Mr. ZHAO became a first-tier senior economist in September 2004, awarded by AVIC. He was awarded an executive master's degree in business administration by the University of Electronic Science and Technology of China, China, in June 2007. Mr. ZHAO has received numerous awards in recognition of his achievements, including the Government Special Allowance awarded by the People's Republic of China State Council in 2000.

Directors and Senior Management

MILAVEC, Robin Zane, aged 54, was appointed as our Executive Director on June 30, 2020. He was appointed as President of the Company on August 17, 2021 and was appointed as Chief Technology Officer and Chief Strategy Officer of the Company on July 1, 2019. In his combined responsibilities, Mr. MILAVEC will facilitate global alignment and teamwork, while spearheading the strategic direction of Nexteer and ensuring technology roadmap alignment with industry mega-trends to proactively capture growth opportunities. Mr. MILAVEC is a member of the GSC. He has over 32 years of relevant experience in the automotive industry, including positions in Product Engineering, Manufacturing Engineering, Operations and Quality. Mr. MILAVEC has been appointed as a director of Nexteer (China) Holding Co., Ltd., a subsidiary of the Group, with effect from August 17, 2021. At the Company, he served as Senior Vice President from July 2019 to August 2021, Vice President of Global Engineering from January 2018 to July 2019, Vice President of Global Current Product Engineering from June 2017 to January 2018, Executive Director of Global Product Engineering from August 2016 to June 2017, Director of Corporate Engineering and Global Programme Office from 2012 to 2016 and Chief Product Engineer for electric power steering from 2009 to 2012. At Delphi Saginaw Steering Systems, he served as Chief Product Engineer for driveline from 2005 to 2009, Chief Manufacturing Engineer for driveline from 2003 to 2005, and as Quality Manager for Saginaw plants 4 and 5 from 2000 to 2003. He served as an Engineering Supervisor at the Delphi Automotive Mexico Technical Centre in Juarez, Mexico from 1995 to 1997. Mr. MILAVEC began his career with General Motors in 1989 as a Product Engineer at the former Saginaw Steering Gear Division, and held several positions in engineering, quality and operations prior to his Mexico assignment in 1995. He obtained a bachelor's degree in mechanical engineering from New Mexico State University in Las Cruces, the US, in 1989 and a master's degree in mechanical engineering from the University of Michigan in Ann Arbor, the US, in 1992.

FAN, Yi (樊毅), aged 55, was appointed as our Director on August 21, 2012 and was designated as our Executive Director on June 15, 2013. He was appointed as our Vice President on November 14, 2013. He had served as our Joint Company Secretary since January 28, 2013 until he became the sole Company Secretary with effect from October 19, 2018. He is responsible for the management of our operations and handling of Company secretarial duties. Mr. FAN is also a member of the GSC. Mr. FAN has approximately 20 years of relevant experience in the automotive industry. Mr. FAN currently serves as a director of our three directly held subsidiaries, Nexteer UK Holding Ltd., Nexteer (China) Holding Co., Ltd., PCM (Singapore) Steering Holding Pte. Limited and as a director of several of our other subsidiaries. Mr. FAN has held the following positions in our controlling shareholders, namely, deputy general manager of AVIC Auto from January 2012 to February 2019; general manager from July 2013 to February 2019 and director and secretary to the board of directors of PCM China from 2010 to November 2020; and the sole director of Nexteer Automotive (Hong Kong) Holdings Limited (**Nexteer Hong Kong**) from August 2012 to November 2020. From 1992 to 1999, Mr. FAN worked at the economic research centre of AVIC. From 1999 to 2005, Mr. FAN served as managing director of the automotive department of China Aviation Industry Corporation II. In 2005, he started working in the automotive department of AviChina Industry & Technology Co., Ltd., a company listed on the Hong Kong Stock Exchange (stock code: 2357), a non wholly-owned subsidiary of AVIC, where he was initially deputy manager, and was later appointed as manager in 2007. Mr. FAN graduated in 1987 from Beijing Aviation Institute of Aeronautics and Astronautics, China (now known as Beijing University of Aeronautics and Astronautics, China) with a bachelor's degree in engineering from the Faculty of Automatic Control, and completed a master's research course in education, economics and management from Beijing University of Aeronautics and Astronautics, China, from 1999 to 2001. Mr. FAN was certified as a researcher in natural sciences by AVIC in September 2007.

Directors and Senior Management

Non-Executive Directors

WANG, Jian (王堅), aged 60, was appointed as our non-Executive Director and Chairman of the Board on June 3, 2019. Mr. WANG resigned as Chairman of the Board and was appointed as a member of the Audit and Compliance Committee with effect from March 16, 2022. Mr. WANG has over 26 years of relevant experience in the automotive industry. From January 2018 to November 2021, Mr. WANG served as the chief economist of AVIC, our controlling shareholder. From August 2020 to May 2021, Mr. WANG served as the chairman of the board of AVIC Auto (a subsidiary of AVIC), our controlling shareholder. From May 2014 to September 2018, he was a director and the chairman of the board of AVIC Electromechanical Systems Co., Ltd. (Stock Code: 002013.SZ), a wholly-owned subsidiary of AVIC. From February 2010 to September 2018, he was a director, executive director and general manager of Aviation Electromechanical Systems Co., Ltd., a wholly-owned subsidiary of AVIC. From January 2013 to May 2014, he was the chairman of the board of Hubei Aviation Precision Machinery Technology Co., Ltd. (known as AVIC Electromechanical Systems Co., Ltd. since February 2014), a non wholly-owned subsidiary of AVIC. From February 2009 to February 2010, he was the deputy general manager of AVIC Electromechanical Systems Co., Ltd., a wholly-owned subsidiary of AVIC. From March 2006 to May 2012, he was a director of China National Aero-Technology Import & Export Corporation, a wholly-owned subsidiary of AVIC, and AVIC International Holding Corporation, a non wholly-owned subsidiary of AVIC, respectively. From October 1998 to February 2010, he was the head of the research centre of the Jincheng Nanjing Engineering Institute of Aircraft Systems, a non wholly-owned subsidiary of AVIC. From October 1998 to February 2010, he successively served as a director, deputy general manager, general manager, vice chairman of the board, as well as chairman of the board and general manager of Jincheng Group Co. Ltd., a wholly-owned subsidiary of AVIC. From August 1982 to September 1998, he successively acted as a technician, head of technical section, head of technical transformation section, head of planning department, head of production department, general manager and chief economist of motor business division, director of technical centre, director of quality control centre, deputy general manager and general manager of Jincheng Machinery Co., Ltd. (金城機械有限公司) (formerly as Jincheng Machinery Plant (金城機械廠)), a wholly-owned subsidiary of AVIC. Mr. WANG holds a postgraduate master's degree. He graduated in July 1982 from Nanjing Aeronautical Institute, China (now known as Nanjing University of Aeronautics and Astronautics, China) with a bachelor's degree majoring in machinery manufacturing engineering. He graduated in March 2003 from Beijing University of Aeronautics and Astronautics, China with a master's degree in economics and obtained a master's degree in business administration from Cheung Kong Graduate School of Business, China in December 2010.

Directors and Senior Management

LEI, Zili (雷自力), aged 51, was appointed as our non-Executive Director on June 8, 2021 and Chairman of the Board on March 16, 2022. Mr. LEI has over 26 years of relevant experience in the automotive industry. As the Chairman of the Board, Mr. LEI is primarily responsible for chairing Board and shareholders' meetings and setting agendas, as well as facilitating communication between the Board and management. Mr. LEI serves as the chairman of Guizhou Guihang Automotive Components Co., Ltd. (a company listed on the Shanghai Stock Exchange, stock code: 600523) since December 2021. He serves as the chairman of AVIC Auto, the chairman and general manager of AVIC Hande (Beijing) Investment Holding Co., Ltd., a non wholly-owned subsidiary of AVIC Auto, the chairman of Henniges Automotive Holdings, Inc. since May 2021. The chairman and general manager of PCM China, the director of Nexteer Hong Kong since November 2020. From March 2013 to July 2020, he served as the executive director and general manager of AVIC Hubei Aviation Precision Machinery Technology Co., Ltd. From September 2000 to March 2013, he served successively as the deputy general manager, general manager of Hubei Aviation Precision Machinery Technology Co., Ltd. (a company listed on the Shenzhen Stock Exchange, Stock Code: 002013). From April 1995 to September 2000, he served successively as the planner, deputy manager and manager of the Planning Department of China Aviation Life-support Research Institute Jiali Branch. From July 1990 to April 1995, he served as the technician in the Petrochemical Department of China Aviation Life-support Research Institute. Mr. LEI graduated from Department of Mechanical Engineering of Zhengzhou University of Aeronautics in July 1990, obtained a master's degree in business administration from Zhongnan University of Economics and Law in October 2005. Mr. LEI is currently a senior economist awarded by the AVIC.

ZHANG, Wendong (張文冬), aged 45, was appointed as our non-Executive Director on November 13, 2020. Ms. ZHANG has served as the deputy general manager of Beijing E-Town International Investment & Development Co., Ltd. since July 2018. From November 2017 to November 2021, Ms. ZHANG served as the non-executive director, the member of audit committee, the member of compensation committee and the member of nominating and corporate governance committee of the board of UTStarcom Holdings Corp, a company listed on NASDAQ (ticker symbol: UTSI). Ms. ZHANG also held various positions in Beijing E-Town International Investment & Development Co., Ltd., including assistant to the general manager from June 2015 to July 2018, the director of asset management department from January 2014 to June 2015 and the deputy director of asset management department from December 2012 to January 2014. From October 2007 to December 2012, she served as the head of the corporate development department of Dongfang Cultural Asset Management Company; from July 2000 to September 2007, she served as the manager of the project department of Beijing Shengandi Investment Management Consulting Company. Ms. ZHANG is currently a senior economist. Ms. ZHANG graduated with a major in economics and obtained a bachelor's degree from Minzu University of China in May 2005. She obtained a master's degree in business administration (MBA) from University of Chinese Academy of Sciences, China in July 2016.

Independent Non-Executive Directors

LIU, Jianjun (劉健君), aged 53, was appointed as our Independent non-Executive Director on June 15, 2013. Mr. LIU was in the legal department of China Ocean Shipping (Group) Company container lines (中國遠洋運輸集團總公司集裝箱運輸) from July 1993 to March 1999, a partner at Zhong Sheng Law Firm, Beijing (北京中盛律師事務所), from April 2001 to October 2006, a senior associate in Zhong Lun Law Firm, Beijing (北京中倫律師事務所) from November 2006 to May 2007, and has been a partner at Zhonglun W&D Law Firm, Beijing (北京中倫文德律師事務所), since June 2007. Mr. LIU started practicing as lawyer in China in August 2001. He obtained a master's degree in law from Peking University, China, in July 1998, and a law degree from Washington University in St. Louis, the USA, in May 2004.

Directors and Senior Management

WEI, Kevin Cheng (蔚成), aged 54, was appointed as our Independent non-Executive Director on June 15, 2013. Mr. WEI is currently a managing partner of a company focused on corporate finance advisory business. Mr. WEI has held the following independent non-executive directorships in publicly listed companies: as an independent non-executive director, the chairman of the audit committee and member of the remuneration committee of the board of Alphamab Oncology, a company listed on the Hong Kong Stock Exchange (stock code: 9966), since December 12, 2019. Mr. WEI's prior directorship include a non-executive director and the chairman of the board and the nomination committee and a member of remuneration committee of Tibet Water Resources Ltd., a company listed on the Hong Kong Stock Exchange (stock code: 1115), since October 2020 to June 2021, the chairman of audit committee of the board of Hunter Maritime Acquisition Corp., a company which was listed on NASDAQ (ticker symbol: HUNT) and delisted from NASDAQ in 2019 from April 2019 to July 2019, and as an independent director and the audit committee chair of Alpha Peak Leisure Inc., a company listed on the Toronto Stock Exchange (TSX-V: AAP), from November 2017 to June 22, 2020. Mr. WEI served as a chief financial officer of IFM Investments Limited, a real-estate services company headquartered in Beijing, from December 2007 to September 2013. IFM Investments Limited was delisted from NYSE in 2015. Prior to that, from 2006 to 2007, Mr. WEI served as the chief financial officer of Solarfun Power Holdings Co., Limited (ticker symbol: SOLF), a NASDAQ listed solar company (now known as Hanwha SolarOne Co., Ltd. and relisted on NASDAQ as Hanwha SolarOne (ticker symbol: HSOL). Mr. WEI became a member of the American Institute of Certified Public Accountants in February 1999. He graduated in June 1991 from Central Washington University, the USA, where he received his Bachelor of Science degree (cum laude) with a double major in accounting and business administration.

YICK, Wing Fat Simon (易永發), aged 63, was appointed as our Independent non-Executive Director on August 15, 2017. Mr. YICK has over 33 years of experience in audit, direct investment, investment banking and corporate advisory services. Since October 1, 2019, Mr. YICK has also been appointed as the independent non-executive director, chairman of audit committee and remuneration committee, member of nomination committee of Modern Media Holdings Limited (Stock code: 72). Mr. YICK currently serves as an independent non-executive director, chairman of the audit committee and member of remuneration committee and member of nomination committee of China Shuifa Singyes Energy Holdings Limited (Stock Code: 750), Shenzhen Neptunus Interlong Bio-technique Co., Ltd. (Stock Code: 8329) and Shanghai International Shanghai Growth Investment Limited (Stock Code: 770) (all of which are listed on the Hong Kong Stock Exchange). Mr. YICK served as an independent non-executive director, convener of the remuneration and assessment committee and a member of the strategy committee of Chengdu Xingrong Environment Co., Ltd. (Stock Code: 000598.SZ), a company listed on the Shenzhen Stock Exchange from August 17, 2015 to August 4, 2020. Mr. YICK was a director of the following Hong Kong incorporated private companies limited by shares which were dissolved by way of deregistration: China Q-Buy Food Company Limited (dissolved on March 2, 2012, which was dormant), Grace Silver Investments Limited (dissolved on October 3, 2008, which was dormant), Daytune Corporate Services Limited (dissolved on August 20, 2004, which provided corporate secretarial services), and Continental Race Limited (dissolved on October 27, 2000, which principally engaged in the leasing of office premises). Mr. YICK confirmed that the aforementioned companies were solvent at the time of dissolution by deregistration and that no misconduct or misfeasance on his part as director led to the relevant company's dissolution, nor is he aware of any actual or potential claim that has been or will be made against him as a result of any of the above dissolutions. Mr. YICK holds a bachelor's degree in business administration, majoring in accounting, from the Chinese University of Hong Kong. He is a fellow member of both the Hong Kong Institute of Certified Public Accountants and the Chartered Association of Certified Accountants in the United Kingdom.

Directors and Senior Management

SENIOR MANAGEMENT

Our senior management is responsible for the day-to-day management of our business. The table below shows certain information in respect of the senior management of our Company (collectively, the **Senior Management**) during the year ended December 31, 2021 and as at the date of this annual report:

Name	Age	Position/Title
BOYER, Hervé Paul	50	Senior Vice President and Global Chief Operating Officer
BIERLEIN, Michael John	45	Senior Vice President and Chief Financial Officer
BENSON, OT	47	Vice President and EMEASA Division President
LI, Jun (李軍)	49	Vice President, APAC Division President and eDrive Product Line
DRALLE, Jill Annette	50	Vice President, Chief Operating Officer – USA
GONZALEZ, Luis Ricardo	62	Vice President, Chief Operating Officer – Mexico
HARRIS, Steven Robert	55	Vice President, Global Engineering
HOEG, Dennis Steven	65	Vice President, Global Manufacturing Operations
PASTOR, Ricardo Antonio	56	Vice President, Global Quality and Programme Launch
ZIPARO, Peter Michael	52	Vice President and General Counsel
XU, Cathy (許瑩)	51	Vice President, Global Human Resources
ORSINI, Salvatore Dino	52	Vice President, Global Chief Supply Chain Management Officer
BYERS, David Michael	56	Vice President, Global Electric Power Steering Product Line

BOYER, Hervé Paul, aged 50, was appointed as our Senior Vice President, Global Chief Operating Officer and North America Division President in August 2021. He leads efforts to enhance Nexteer's operational efficiencies and profitability – including Nexteer's day-to-day value chain management and profit & loss performance across all divisions. He is also a member of the GSC. Mr. BOYER has over 23 years of relevant experience in the automotive industry. From March 2016 to August 2021, Mr. Boyer held the position of Vice President, Divisional President – EMEASA Division. Prior to Nexteer, from May 2015 to February 2016, Mr. BOYER held the position of executive director of the NBHX Electronics group where he had the responsibility to run the Interior Trims business. Mr. BOYER spent several years within the Faurecia group where he served as president of North America Operations from June 2012 to July 2014 for the Interior Systems business group. From January 2009 to June 2012, Mr. BOYER was vice president of the South Europe perimeter of Faurecia Interior Systems and previously served as vice president for French, US and Japanese Divisions, from May 2008 to December 2008. Mr. BOYER has also served as director for the Renault-Nissan Division from January 2006 to May 2008. From 2001 to 2005, Mr. BOYER held several sales and marketing positions at Faurecia Interior Systems and served as programme manager from September 1994 when he joined Sommer Allibert Industrie which was acquired by Faurecia group in late 2000. Mr. BOYER earned a degree in manufacturing engineering from L'Ecole Centrale de Nantes, France, in 1994 and attended the Advance Management Programme of Harvard Business School, the USA, in 2014.

BIERLEIN, Michael John, aged 45, was appointed as our Senior Vice President and Chief Financial Officer in September 2021. He is responsible for overseeing investor relations, treasury, capital funding and structure, mergers and acquisitions support, accounting and financial reporting, and financial planning and analysis. He is also a member of the GSC. Mr. BIERLEIN has 24 years of relevant experience in the automotive industry. From August 2020 to August 2021, Mr. BIERLEIN served as Nexteer's North America Chief Financial Officer and Global Engineering Finance after serving as Executive Director, Strategic Financial Planning from March 2015 to August 2020. Prior to joining Nexteer, Mr. BIERLEIN spent 17 years with Delphi Corporation in a variety of financial leadership roles both at a divisional and corporate level ranging from Financial Director and Controller to Senior Manager – Strategic Planning, Labour Negotiations, Financial Planning and Analysis and Plant Controller. Mr. BIERLEIN earned a degree in Finance in 1998 and a Masters of Business Administration in 2003 from Michigan State University, the USA.

Directors and Senior Management

BENSON, OT, aged 47, was appointed as our Vice President, EMEASA Division President and is responsible for the EMEASA Division, gaining commitments from the business lines and leveraging corporate functions to meet the business plan of the division. Mr. BENSON is a member of the GSC. He offers nearly 15 years of service in the automotive industry, primarily within global supply chain management, in addition to 8 years of active duty service in the United States Air Force. Mr. BENSON most recently served as Vice President, Global Sales and Marketing since June 2019 and Vice President, Global Supply Management (**GSM**) since June 2018 and Director of North America GSM since 2013. In these roles, Mr. BENSON was responsible for managing supply chain operations, developing supplier relationships and delivering benchmark material cost, quality and launch performance to our North America plants in the US and Mexico. In 2017, Mr. BENSON rejoined Nexteer after serving two years as vice president of Global Procurement at Nidec Motor Corporation. Mr. BENSON began his career with Delphi Steering's GSM team in 2005, where he held positions including China business line purchasing manager, Suzhou Steering Purchasing Manager and Enterprise Commodity Manager. Mr. BENSON holds a bachelor of Science in marketing and Asian studies from Utah State, the USA; a Master of Business Administration in international management from East Carolina University, the USA; and a Master of Arts in Chinese linguistics from the University of Hawaii at Manoa, the USA.

LI, Jun (李軍), aged 49, was appointed as our Vice President, APAC Division President and eDrive Product Line on January 1, 2022. In this role, he is responsible for leading and achieving the strategic objectives of the APAC Division, as well as leading global cross-functional collaboration to define and execute this product line's technology, portfolio strategy, customer strategy and industrialisation plans. He is a member of the GSC. Mr. LI offers over 20 years of relevant experience in the automotive industry. Prior to his current role, Mr. LI was Vice President and APAC Division President from November 2017 to January 2020 and he was responsible for eDrive product line from January 2020 to December 2021. From October 2016 to November 2017, Mr. LI was Executive Director and Chief Operating Officer – Asia Pacific Division with the same responsibility. Before that, he served as Asia Pacific Steering Business Director from February 2015 to October 2016 and was responsible for developing the overall business plan and competitiveness. From May 2012 to January 2015, Mr. LI held the position as General Manager to oversee the operations of Nexteer Automotive (Suzhou) Co., Ltd. (**Nexteer Suzhou**). From 2010 to May 2012, Mr. LI served as Plant Manager and was responsible for the overall operational management of Nexteer Suzhou Plant 53. During 2008 and 2010, he took the role as Programme Manager of China's first EPS Programme at Saginaw Steering (Suzhou) Co., Ltd. From 2004 to 2007, Mr. LI served as Programme Launch Manager and Engineering Manager at Delphi Automotive in Shanghai. Prior to joining Nexteer and Delphi Automotive, he held various supervisory positions in manufacturing, project management and engineering at Dongfeng Motor Group for 6 years, and 5 years at China Aerospace Science and Technology Corporation. He obtained a Diploma in Science and Technology in mechanical engineering from Huazhong University of Science & Technology, China in 1991, and a master's degree in business administration from the University of Electronic Science & Technology of China, China, in 2004.

DRALLE, Jill Annette, aged 50, was appointed as our Vice President, Chief Operating Officer, USA on March 17, 2021. She is responsible for the entire USA business, gaining commitments from the business lines and leveraging corporate functions to meet the business plan of the division. Ms. DRALLE brings over 26 years of relevant automotive experience. Prior to her current role, she was Chief Operating Officer of US Operations with a dual role as General Manager of the Columns-HPS Business Unit in Saginaw from May 2019 to March 2021. Ms. DRALLE has held many essential positions at Nexteer since 2008. She was Executive Director of Operational Excellence & Strategy for North America from 2014 to 2018, Plant Manager of Driveline from 2012 to 2014, Plant Operations Manager from 2011 to 2012, and Lean Change Agent for multiple plants from 2008 to 2011. Before Ms. DRALLE joined Nexteer she worked at Delphi Automotive Systems in varying key roles in industrial and manufacturing engineering, quality and operations management. Ms. DRALLE began her automotive career in 1994 with General Motors at the former Saginaw Steering Gear Division and held numerous assignments of increasing responsibility in manufacturing engineering. Ms. DRALLE obtained a bachelor's degree in engineering from Saginaw Valley State University, the USA, in 1993 and was honoured as a distinguished alumni in 2019.

Directors and Senior Management

GONZALEZ, Luis Ricardo, aged 62, was appointed as our Vice President, Chief Operating Officer, Mexico on March 17, 2021. He is responsible for our Mexico Operations. He has over 36 years of operational experience and 28 years of automotive experience. Mr. GONZALEZ previously served as Chief Operating Officer, Mexico from 2017 to 2021. He was also the Mexico Operations Director from 2011 to 2017. Prior to joining Nexteer, Mr. GONZALEZ served as the Director of Mexico Manufacturing Operations and Country Manager at Autoliv Inc. He has also held impactful roles at Sensata, TRW Automotive, and Siemens. Mr. GONZALEZ holds a bachelor's degree in industrial and systems engineering from Instituto Tecnológico y de Estudios Superiores de Monterrey (ITESM) (Monterrey Institute of Technology and Higher Education), Mexico, in 1980. He also obtained a master's degree in industrial engineering from Georgia Institute of Technology, the USA, in 1983 and a Master of Business Administration from Webster University, the USA, in 1993.

HARRIS, Steven Robert, aged 55, was appointed as our Vice President, Global Engineering in July 2021. He is responsible for global product and manufacturing engineering activities, implementing the product portfolio and production support. He is also a member of the GSC. Mr. HARRIS has over 33 years of relevant automotive experience. Over his career at Nexteer, which began in 1989 as GM/Delphi Steering Systems, he has held multiple, progressive leadership positions across the hydraulic power steering product line (HPS), and electric power steering (EPS) product line. From 2012 to 2016, Mr. HARRIS took an international assignment in Nexteer APAC Suzhou, China starting as Senior Manager EPS Product Engineering, followed by Chief Product Engineer, Steering Systems, before being appointed APAC Engineering Director. In 2016, Mr. HARRIS returned to the US as Executive Director for EPS Product Engineering. Mr. HARRIS earned a degree in Mechanical Technology from Purdue University, the USA, in 1988 and an MBA from the University of Michigan-Flint, the USA, in 1996.

HOEG, Dennis Steven, aged 65, was appointed as our Vice President of Global Manufacturing Operations on July 1, 2021. He is responsible for defining manufacturing operations priorities and leading the regional operations teams to implement improvements to achieve manufacturing cost, delivery and quality expectations. In addition to this operations role, he also manages Capital Spending and US Governmental Affairs. He was previously Vice President, North America Division President. He has 40 years relevant automotive experience and is also a member of the GSC. Mr. HOEG served as Vice President of Engineering at Nexteer Automotive from June 2011 to November 2012. He was Executive Director of Global Supply Management from 2007 to 2011, Director of Global Manufacturing Engineering from 2002 to 2007, and Plant Manager from 1999 to 2002 at Delphi Saginaw Steering Systems. Mr. HOEG began his automotive career with GM in 1978 as a Manufacturing Engineer at the former Saginaw Steering Gear Division. In 1997, he was Programme Manager for the GMT800 and L/N/P90 programmes in Plant 7, Chief Manufacturing Engineer for Hydraulic Steering in 1994, and Staff Engineer for integral gears in 1992. Following a number of assignments that included Plant Engineer, Process Engineer, Advanced Manufacturing Engineer, and Assistant Staff Engineer, he served as the Value Stream Manager for steering valves at Plant 7 in 1988. He obtained a bachelor's degree in mechanical engineering from Iowa State University, the USA, in May 1978, and a Master of Science from Purdue University, the USA, in May 1983.

PASTOR, Ricardo Antonio, aged 56, was appointed as our Vice President, Global Quality and Programme Launch on November 16, 2017. He is responsible for all facets of the Global Quality function including strategic planning, execution, measurement and administration of quality systems and controls. He is also in charge of Customer Programme Implementation (**CPI**) where he leads the optimisation of the CPI process and oversees programme launches to ensure successful performance. Mr. PASTOR is a member of the GSC. Mr. PASTOR brings over 33 years of experience in the automotive industry. Mr. PASTOR served as Executive Director of Global Quality at Nexteer since June 2015. Prior to leading the Global Quality function, he was Quality Director for the International and China Divisions from 2010 to 2015. Mr. PASTOR was senior manager in manufacturing planning in 2009, Director of footprint expansion for Asia Pacific from 2006 to 2009 and Chief Engineer for Europe from 2004 to 2006 at Delphi Automotive. Mr. PASTOR held many other leadership positions in engineering quality and programme launch prior to 2006. Over his career, Mr. PASTOR had nine years of expatriate assignments between Europe and China. Mr. PASTOR began his automotive career with General Motors in 1984 at the former Saginaw Steering Gear Division. He obtained a Bachelor of Science degree in electrical engineering with minors in mathematics and chemistry, summa cum laude, from Saginaw Valley State College, the USA, in 1987 and a Master of Science degree in electrical engineering from Oakland University, the USA, in 1990.

Directors and Senior Management

ZIPARO, Peter Michael, aged 52, was appointed as our Vice President and General Counsel on December 1, 2016. He is responsible for managing all global legal and compliance matters for the Group. Mr. ZIPARO offers over 16 years of relevant experience in the automotive industry and over 24 years of legal experience. Mr. ZIPARO is also a member of the GSC. Prior to joining Nexteer, he served as vice president and general counsel of Visteon Corporation, a Tier-One automotive supplier from April 2014 to March 2016, an assistant general counsel from 2005 to 2014 and an associate general counsel from 2002 to 2005. Mr. ZIPARO's experience also includes posts as corporate associate with international law firms, Morrison & Foerster LLP and Chadbourne & Parke LLP. He obtained a bachelor's degree, with honours in mathematics, from Hamilton College, the USA, in May 1991 and a juris doctor degree, magna cum laude, from Albany Law School, the USA, in May 1994.

XU, Cathy (許瑩), aged 51, was appointed as our Vice President, Global Human Resources (**HR**) on June 4, 2018 and is responsible for all HR activities, including leading the global HR team to cultivate our "One Nexteer" culture at all levels of the organisation. Ms. XU is a member of the GSC. She offers more than 15 years of service in the automotive industry and 27 years of experience in the HR function. Ms. XU most recently served as Executive Director, Global HR since June 2017. In this role, Ms. XU was responsible for establishing global HR strategies and enhancing the global HR team's competencies. Ms. XU joined the Company in 2006, based in Suzhou, China, where she has served as Divisional HR Director of Asia Pacific, Country HR Director of China and Plant HR Manager of Suzhou, China. Ms. XU holds a Bachelor of Science in business administration and a Master of Executive Business Administration from Nanjing University, China.

ORSINI, Salvatore Dino, aged 52, was appointed as our Vice President, Global Chief Supply Chain Management Officer on March 17, 2021. He is responsible for managing all aspects of Nexteer's global supply chain operations, including Direct Material, Indirect Material, Product Line Purchasing, Strategic Commodity Management, and Supplier Quality & Development objectives. Mr. ORSINI is a member of the GSC. He brings over 25 years of global supply chain management experience from the automotive and aerospace industries. Prior to his current role, he was Executive Director, Global Supply Chain Management from June 2020 to March 2021. Before Mr. ORSINI joined Nexteer, he was the director of purchasing, Chassis at General Motors Company from 2013 to 2019. His experience also includes global leadership roles at Rolls-Royce Aerospace, Aptiv, and Delphi. Mr. ORSINI obtained a bachelor's degree in business administration from Central Michigan University, the USA, in 1993.

BYERS, David Michael, aged 56, was appointed as our Vice President, Global Electric Power Steering Product Line on March 17, 2021. He is responsible for developing the overall global EPS product line business plan, strategy and competitiveness. He is a member of the GSC. Mr. BYERS has over 33 years of automotive engineering experience. He previously served as Product Line Executive Director – Global EPS from December 2019 to March 2021. He has been an impactful leader at Nexteer, Delphi and GM serving in different roles such as Product Line Executive Director for Rack EPS, Chief Manufacturing Engineer and other leadership roles within engineering. Overall, Mr. BYERS has 15 years of product engineering experience, 15 years of manufacturing engineering/operations experience and 3 years of Product Line Management experience. He has been responsible for 11 US patents and 4 defensive publications throughout his career. Mr. BYERS began his automotive career with General Motors in 1987 at the former Saginaw Steering Gear Division. He obtained a Bachelor of Science degree in mechanical engineering from Clarkson University, the USA, in 1987 and a Master of Business Administration from the University of Michigan – Flint, the USA, in 1993.

RELATIONSHIPS BETWEEN DIRECTORS AND SENIOR MANAGEMENT

None of the Directors or members of the Senior Management are related to any other Director or member of the Senior Management.

Directors' Report

The Directors are pleased to present their report together with the Consolidated Financial Statements.

CORPORATE INFORMATION AND GLOBAL OFFERING

The Company was incorporated in the Cayman Islands on August 21, 2012 as an exempted company with limited liability under the Companies Laws (as amended), of the Cayman Islands (the **Companies Law**). The Company's shares (the **Shares**) were listed on the Hong Kong Stock Exchange on October 7, 2013.

PRINCIPAL ACTIVITIES

The Group develops, manufactures and supplies advanced steering and driveline systems to OEMs throughout the world.

BUSINESS REVIEW

A review of the business of the Group for the year ended December 31, 2021 and a discussion on the Group's future prospects are provided in the Management Discussion and Analysis on pages 38 through 49 and in the CEO Statement on pages 7 through 9. An analysis of the Group's performance during the year using financial key performance indicators is provided within the Financial Highlights on page 37. In addition, discussions on the Group's key policies, relationships with its key stakeholders and compliance with relevant laws and regulations which have a significant impact on the Group are contained in the Corporate Governance Report on pages 78 through 89 and in this Directors' Report.

KEY RISK AND UNCERTAINTIES

The Group's financial condition, results of operations, businesses and prospects may be affected by a number of risks and uncertainties. The following are the key risks and uncertainties identified by the Group. There may be other risks and uncertainties in addition to those shown below which are not known to the Group or which may not be material now but could turn out to be material in the future.

Operational Risk

Operational risk is the risk of loss resulting from inadequate or failed internal processes, people and systems or from external events. Responsibility for managing operational risks rests with every function at divisional and department levels. The Group recognises that operational risks cannot be eliminated completely and that it may not always be cost-effective to do so.

Key functions in the Group are guided by their standard operating procedures, limits of authority and reporting framework. Functions such as, but not limited to, Internal Audit and Internal Control have the responsibility for providing assurance on the internal control framework. Key operational risk exposures are communicated to Senior Management as early as possible so that appropriate risk response can be taken.

Financial Risk

In the course of business activities, the Group is exposed to a variety of financial risks, including market, liquidity and credit risks. The currency environment, interest rate cycles and mark-to-market value of investment securities may pose significant risks to the Group's financial condition, results of operations and businesses. The financial risk management objectives and policies of the Group can be found in note 3 to the Consolidated Financial Statements.

Directors' Report

Business Risks

Cyclical industry and a decline in production levels

Our sales are driven by the number of vehicles produced by the automotive manufacturers which is ultimately dependent on consumer demand. The automotive industry is cyclical and sensitive to general economic conditions, including the global credit markets, interest rates, consumer credit, and consumer spending and preferences. Automotive sales and production can also be affected by the age of the vehicle fleet and related scrappage rates, labour relation issues, fuel prices, regulatory requirements, government initiatives, trade agreements, restructuring actions of our customers and suppliers, increased competition and other factors.

Concentration of sales and terms and conditions of the agreement with GM

The supply of products to GM are governed by various agreements and standard terms and conditions applicable to each programme. Certain limited programmes also remain subject to a supply agreement, dated November 30, 2010, pursuant to which we have agreed to continue to manufacture and deliver certain products to GM. For the years ended December 31, 2020 and 2021, our largest customer, GM, accounted for approximately 35% and 32% of our consolidated revenues, respectively. A significant decrease in business from GM could materially and adversely impact our business, results of operations and financial condition.

Loss of business or lack of commercial success

Purchase orders generally provide for the supply of a customer's annual requirements for a particular vehicle model, and in some cases, for the supply of a customer's requirements for the life of a particular vehicle model, rather than for the purchase of a specific quantity of products. Lack of commercial success could reduce our revenues or margins and thereby adversely affect our financial condition, operating results and cash flows.

Inability to achieve product cost reductions

During negotiations with the customers, customers tend to demand price reduction over the life of a vehicle model. We also bear significant responsibility on the product design, development and manufacturing engineering. Our financial performance is largely dependent on our ability to achieve product cost reductions through product design enhancement and manufacturing efficiencies. If we fail to achieve cost reductions, it would adversely affect our financial condition, operating results and cash flows.

Increase in costs and restrictions on availability of raw materials and component supply

The cost of raw materials accounted for approximately 62.6% and 60.1% of our consolidated revenues for the years ended December 31, 2021 and 2020, respectively. Raw material, energy, and commodity costs can be volatile. If the costs of raw materials, energy, commodities, and product components increase or the availability thereof is restricted, it could adversely affect our financial condition, operating results and cash flows.

The COVID-19 pandemic and government actions and measures taken to prevent its spread continue to affect our operations. In response to COVID-19, we previously suspended the majority of our global manufacturing operations. By May 2020, we had resumed our global manufacturing operations. Government-imposed restrictions on businesses, operations and travel, and the related economic uncertainty, have impacted demand for our customers' vehicles in most global markets. The extent of COVID-19's impact on our future operations, liquidity and the demand for our products will depend upon, among other things, the duration and severity of the outbreak or subsequent outbreaks, related government responses, such as required physical distancing or restrictions on business operations and travel, the pace of recovery of economic activity and the impact to our customers, the effectiveness of available vaccines and any potential supply disruptions, all of which are uncertain and difficult to predict in light of the rapidly evolving landscape.

As a result of the COVID-19 pandemic and other factors, the automotive industry and the Company are currently experiencing global shortages in the supply of various sub-components and raw materials, including semi-conductors. These supply shortages have impacted multiple customers and suppliers resulting in reductions or suspension of vehicle production. We expect these supply shortages will have a short-term impact on our business, however, there can be no assurance that these supply shortages will not continue longer than expected or expand to other materials used by the Company, its suppliers or its customers and may have a significant impact on our future operations and liquidity.

Directors' Report

Conflict in Ukraine

In February 2022, Russian military forces entered Ukraine resulting in a military conflict between the two countries (the **Ukraine Conflict**). In response, many countries, including the U.S., the United Kingdom and the European Union, have imposed unprecedented sanctions and controls on certain Russian citizens, organisations and goods. The Ukraine Conflict is likely to impact the Company and the global automotive industry, including the availability and pricing of raw materials, energy, commodities, and product components, the ability of OEMs to meet production forecasts and/or impact the global consumer demand for vehicles. Any of these effects could adversely affect our financial condition, operating results and cash flows.

Substantial international operations

As a result of our global presence, a significant portion of our revenues and expenses are denominated in currencies other than the US dollar. International operations are subject to certain risks inherent in doing business abroad, including exposure to local economic conditions; political, economic, and civil instability and uncertainty; labour unrest; an outbreak of a contagious disease, an epidemic or pandemic or other public health crises, which may cause us or our suppliers and/or customers to temporarily suspend operations in the affected city or country; currency exchange rate fluctuations and the ability to hedge currencies; and increases in working capital requirements related to long supply chains.

Highly competitive industry and efforts by our competitors to gain market share

We operate in a highly competitive industry and our competitors are seeking to expand market share with new and existing customers. Our competitors' efforts to grow market share could create downward pressure on our product pricing and margins. If we are unable to differentiate our products or maintain a low-cost footprint, we may lose market share or be forced to reduce prices, thereby lowering our margins. Any such occurrence could adversely affect our financial condition, operating results and cash flows.

Our existing indebtedness and the inability to access capital markets

As at December 31, 2021, we had approximately US\$84.4 million of outstanding indebtedness, as well as US\$283.7 million available but not yet drawn under our credit facilities. The debt instruments governing our indebtedness contain covenants that may restrict our business activities or our ability to execute our strategic objectives, and our failure to comply with these covenants could result in a default under our indebtedness. Additionally, any downgrade in the ratings that rating agencies assign to us and our debt may ultimately impact our access to capital markets. Our inability to generate sufficient cash flow to satisfy our debt and lease obligations, to refinance our debt obligations or to access capital markets on commercially reasonable terms could adversely affect our financial condition, operating results and cash flows.

Impairment charges relating to our long-lived assets

We regularly monitor our long-lived assets for impairment indicators. Our consolidated balance sheet as at December 31, 2021 reflects a carrying amount of capitalised engineering and product development costs of US\$707.8 million, a carrying amount of property, plant and equipment of US\$988.9 million and a carrying amount of right-of-use assets of US\$63.4 million. In the event that we determine that our long-lived assets are impaired, we may be required to record a significant charge to earnings that could adversely affect our financial condition or operating results as set out in notes 2.8, 6 and 8 to the Consolidated Financial Statements.

Our intellectual property portfolio

We own intellectual property, including patents, trademarks, copyrights and trade secrets. In some cases, we enter into licensing agreements with respect to intellectual property. In addition, we rely on unpatented proprietary technology. These assets play an important role in maintaining our competitive position. We may assert claims against third parties that we believe are infringing on our intellectual property rights. These claims, regardless of their merit or resolution, are typically costly to pursue. Risks related to the protection of our intellectual property could have a material adverse effect on our business, results of operations and financial condition.

Directors' Report

Significant product liability lawsuit or warranty claim

In the event that our products fail to perform as expected, whether alleged or due to an actual fault, we may be subject to product liability lawsuits and other claims or we may be required by our customers or regulators to participate in a recall or other corrective action involving such products. We have also entered into agreements with certain customers where these customers may pursue claims against us for all or a portion of the amounts sought in connection with product liability and warranty claims. We carry insurance for certain product liability claims, but such coverage may be limited. These types of claims could adversely affect our financial condition, operating results and cash flows. As at December 31, 2021, our consolidated balance sheet includes provisions totalling US\$55.8 million related to estimated warranty and product liability obligations.

Information technology

A failure of our information technology (**IT**) infrastructure could adversely impact our business and operations. We rely on the capacity, reliability and security of our IT systems and infrastructure. IT systems are vulnerable to disruptions, including those resulting from natural disasters, cyber-attacks or failures in third-party provided services. Disruptions and attacks on our IT systems pose a risk to the security of our systems and our ability to protect our networks and the confidentiality, availability and integrity of our third-party data. As a result, such attacks or disruptions could potentially lead to the inappropriate disclosure of confidential information, including our intellectual property, improper use of our systems and networks, manipulation and destruction of data, production downtimes and both internal and external supply shortages. This could cause significant damage to our reputation, affect our relationships with our customers and suppliers, lead to claims against the Company and ultimately, adversely affect our business.

Environmental laws and regulations

Our global facilities are subject to numerous laws and regulations designed to protect the environment. If we fail to comply with present and future environmental laws and regulations, we could be subject to future liabilities, which could adversely affect our financial condition, operating results and cash flows.

Global climate change and related emphasis on ESG matters by various stakeholders could negatively affect our business

Increased public awareness and concern regarding global climate change may result in more regional, federal, national and/or international requirements to reduce or mitigate the effects of greenhouse gas (**GHG**) emissions. There continues to be various and complex climate legislation, which creates economic and regulatory uncertainty. Such regulatory uncertainty extends to future incentives for energy efficient vehicles and costs of compliance, which may impact the demand and supply for our products and our results of operations.

There is a growing consensus that GHG emissions are linked to global climate changes. Climate changes, such as acute and chronic conditions, create potential financial risk to our business. For example, the demand for our products and services may be affected by unseasonable weather conditions. Climate changes could also disrupt our operations by impacting the availability, cost of materials and logistics needed for manufacturing and could increase insurance and other operating costs. These factors may impact our decisions to construct new facilities or maintain existing facilities in areas most prone to physical climate risks. Besides physical climate risks, the Company could also be subject to transition climate risks in the form of rising cost of carbon, market and technology risk exposures during transition to a low-carbon economy.

Further, stakeholder expectations, such as those from customers, investors, and employees in ESG subjects have been rapidly evolving and increasing. For example, certain customers are beginning to require that the Company provide information on its plans relating to certain environmental sustainability-related matters, such as GHG emissions and renewable energy. The enhanced stakeholder focus on ESG issues relating to the Company requires the continuous monitoring of various and evolving standards and the associated reporting requirements. A failure to adequately meet stakeholder expectations may result in the loss of business, diluted market valuation, an inability to attract customers or an inability to attract and retain top talent.

Directors' Report

Income tax legislation and regulatory environment

The Company continues to monitor the developments by the office of Organisation for Economic Cooperation and Development (**OECD**) on its continued efforts toward its Base Erosion and Profit Shifting initiative by focusing on two pillars which could affect the Company's effective tax rate. Pillar One addresses tax presence in a country and profit allocation between countries. Pillar Two, also known as Global-Anti Base Erosion Rules (**GLoBE**), is designed to ensure large multinational enterprises (**MNEs**) pay a 15% minimum tax. The precise timing of implementation for both Pillar One and Pillar Two is uncertain. However, the shape and implementation of this reform may adversely impact the Company's consolidated effective tax rate.

The Company continues to monitor proposed changes to US tax laws and regulations that have been proposed by US Congress which could affect the Company's effective tax rate. Since the likelihood of these or other changes to US tax law being enacted are unclear, the Company is currently unable to determine the impact these changes may have to its tax expense, including if the proposed changes may materially impact the Company's earnings and cash flows.

The preferential tax treatment that our People's Republic of China (**PRC**) subsidiaries enjoy may be changed or discontinued, which may adversely affect our business, result of operations and financial condition. Nexteer Automotive Suzhou Co., Ltd., Nexteer Lingyun Driveline (Zhuozhou) Co., Ltd. and Nexteer Lingyun Driveline (Wuhu) Co., Ltd. are expected to maintain high-tech certificates, which are scheduled to expire in 2023, 2022 and 2022, respectively. In 2022, both Zhouzhou and Wuhu will file applications to extend their high-tech certificate through 2024. In order to maintain eligibility for the preferential income tax rate of 15%, the subsidiaries are obligated to meet on-going requirements. We cannot assure that we will maintain this preferential tax rate for future periods. Nexteer Automotive Systems (Liuzhou) Co., Ltd. received a special 'Go West' preferential 15% income tax rate through 2030.

Any of these changes could impact the Company, our shareholders, and affiliates, and could adversely affect the Company by changing our effective tax rate and limiting the Company's ability to utilise cash in a tax efficient manner.

Strategic Objectives Risk

Our financial performance depends, in part, on our ability to successfully execute our strategic objectives. Our strategy is to deliver superior long-term shareholder value by growing our business through investments and improving our competitive position, while maintaining a strong balance sheet and returning cash to our shareholders. Our failure to execute our strategic objectives could adversely affect our financial condition, operating results and cash flows.

Joint Venture Partners Risk

Some of the businesses of the Group are conducted through non wholly-owned subsidiaries, associates, joint ventures and joint operations in which the Group shares control with the joint venture partners. There is no assurance that any of these joint venture partners will continue their relationships with the Group in the future or whether their goals or strategies are in line with the Group. Such joint venture partners may have business interests or goals which are different from the Group. They may experience financial and other difficulties or may be unable to fulfill their obligations under the joint ventures which may affect the Group's businesses and operations.

Directors' Report

FINAL DIVIDEND

The Board recommends the payment of a final dividend of approximately US\$23.8 million, or approximately US\$0.0095 per Share, which represents approximately 20% of the Group's net profit attributable to equity holders for the year ended December 31, 2021, subject to the approval of the shareholders at the forthcoming annual general meeting of the Company (the **AGM**).

The payment shall be made in US dollars, except that payment to shareholders whose names appear on the register of members in Hong Kong shall be paid in Hong Kong dollars. The relevant exchange rate shall be the opening buying rate of Hong Kong dollars to US dollars as announced by the Hong Kong Association of Banks (www.hkab.org.hk) on the day of the approval of the distribution at the AGM.

DISTRIBUTABLE RESERVES

As at December 31, 2021, the Company's reserves available for distribution, calculated in accordance with the provisions of the Companies Law, amounted to approximately US\$479.6 million (as at December 31, 2020: US\$440.4 million).

SHARE CAPITAL

Details of movements in the share capital of the Company during the year ended December 31, 2021 are set out in note 33 to the Consolidated Financial Statements.

PRE-EMPTIVE RIGHTS

There are no provisions for pre-emptive rights under the Amended and Restated Memorandum and Articles of Association of the Company (the **Articles of Association**) or the laws of the Cayman Islands that would oblige the Company to offer new Shares on a pro-rata basis to existing shareholders.

EQUITY-LINKED AGREEMENTS

Details of the share options granted in prior years and current year are set out in note 24 of the Consolidated Financial Statements and 'Share Option Scheme' section contained in this Directors' Report. There were no share options granted during the year ended December 31, 2021. Except as disclosed above, the Company has not entered into any equity-linked agreements for the year ended December 31, 2021.

ESG SUMMARY

The Group is committed to conducting our business in an environmentally sound manner and has adopted the ESG Reporting Guide as required by the Listing Rules. The Board will continue to monitor such policies to ensure the Company remains compliant with the relevant laws and regulations that have a significant impact on the Company in relation to the environment, employment, labour and operation. In addition to carrying out the corporate-wide programmes the Company has initiated, all of our employees are required to be familiar with environmental laws and regulations relevant to their employment responsibilities and to comply with them. In accordance with the ESG Reporting Guide, as set out in Appendix 27 to the Listing Rules, details of the above information will be set out in our ESG report (annual Sustainability Report), which is to be published on www.nexteer.com by the end of May 2022.

CHARITABLE DONATIONS

During 2021, the charitable contributions and other donations made globally by us amounted to US\$0.2 million.

In 2021, our employees volunteered more than 15,000 hours of time supporting local charitable efforts and creating brand awareness through the Company's philanthropic activities.

DIRECTORS

The Directors in office during the year ended December 31, 2021 and as at the date of this annual report were as follows:

Executive Directors

ZHAO, Guibin (趙桂斌) (*Vice Chairman*)

MILAVEC, Robin Zane

FAN, Yi (樊毅)

Non-Executive Directors

WANG, Jian (王堅) (resigned as Chairman with effect from March 16, 2022)

LIU, Ping (劉平) (retired with effect from June 8, 2021)

ZHANG, Wendong (張文冬)

Mr. LEI, Zili (雷自力) (*Chairman*) (appointed as non-Executive Director with effect from June 8, 2021 and as Chairman of the Board with effect from March 16, 2022)

Independent Non-Executive Directors

LIU, Jianjun (劉健君)

WEI, Kevin Cheng (蔚成)

YICK, Wing Fat Simon (易永發)

Further details of the Directors are set forth in the section headed 'Directors and Senior Management' in this annual report.

Pursuant to Article 16.2 of the Articles of Association, any Director appointed by the Board, either to fill a casual vacancy or as an addition to the existing Directors, shall hold office only until the next following AGM of the Company and shall then be eligible for election at that meeting.

Pursuant to Article 16.18 of the Articles of Association, at every AGM one-third of the Directors for the time being shall retire from office by rotation provided that every Director shall be subject to retirement by rotation at least once every three years.

Details of the Directors to be re-elected at the AGM will be set out in the circular to the shareholders of the Company prior to its upcoming AGM.

Directors' Report

CHANGES TO INFORMATION IN RESPECT OF DIRECTORS

Mr. WANG, Jian, a non-Executive Director of the Company, has tendered his resignation as the Chairman of the Board with effect from March 16, 2022. Mr. WANG will continue to be a non-Executive Director of the Company after his resignation as the Chairman of the Board. The director's fee of Mr. WANG is adjusted to US\$42,000 per annum and he is entitled to receive a discretionary bonus as determined by the Board with reference to the experience, responsibility, workload, time devoted, contributing to the Group, emoluments paid by comparable companies and performance of the Group.

Mr. LEI, Zili, a non-Executive Director of the Company, was appointed by the Board as the Chairman of the Board with effect from March 16, 2022. The director's fee of Mr. LEI is adjusted to US\$124,000 per annum and he is entitled to receive a discretionary bonus as determined by the Board with reference to the experience, responsibility, workload, time devoted, contributing to the Group, emoluments paid by comparable companies and performance of the Group.

Except as disclosed above and in the section headed 'Directors and Senior Management' in this annual report, there was no change to any of the information required to be disclosed in relation to any Director pursuant to paragraphs (a) to (e) and (g) of Rule 13.51(2) of the Listing Rules since the publication of the 2021 interim report of the Company.

SERVICE CONTRACTS OF DIRECTORS

Executive Directors

Each of the Executive Directors has entered into a service contract with the Company pursuant to which they agreed to act as Executive Directors for a term of three years with effect from June 15, 2019, June 3, 2019 or June 30, 2020, which shall be renewed as determined by the Board or the shareholders of the Company. The appointment of each of the Executive Directors may be terminated by either party by giving at least three months' written notice to the other.

Non-Executive Directors

Each of the non-Executive Directors has entered into a service contract with the Company pursuant to which they agreed to act as a non-Executive Director for a term of three years with effect from June 3, 2019, November 13, 2020 or June 8, 2021, which shall be renewed as determined by the Board or the shareholders of the Company. The appointment of each of the non-Executive Directors may be terminated by either party by giving at least three months' written notice to the other.

Independent Non-Executive Directors

Each of the Independent non-Executive Directors has been appointed for a term of three years with effect from June 15, 2019 or August 15, 2020, which shall be renewed as determined by the Board or the shareholders of the Company. The appointment of each of the Independent non-Executive Directors may be terminated by either party giving at least three months' written notice to the other.

All of the appointments of Directors are subject to the provisions of the Articles of Association with regard to vacating the office of Directors, removal and retirement by rotation of Directors. Except for directors' fees, none of the Independent non-Executive Directors is expected to receive any other remuneration for holding their office as an Independent non-Executive Director.

None of the Directors who are proposed for re-election at the forthcoming AGM has or is proposed to have a service contract that is not terminable by the Company within one year without the payment of compensation (other than statutory compensation).

DIRECTOR'S INTERESTS IN TRANSACTIONS, ARRANGEMENTS AND CONTRACTS

There were no transactions, arrangements and significant contracts with any member of the Group as the contracting party and in which the Directors and the Directors' connected party possessed direct or indirect substantial interests, and which was still valid on December 31, 2021 or at any time during such year and related to the business of the Group.

DIRECTORS' INTERESTS IN COMPETITIVE BUSINESS

During the year ended December 31, 2021, none of the Directors are considered to have interest in a business which competes or is likely to compete, either directly or indirectly, with the business of the Group.

PERMITTED INDEMNITY

Article 33 of the Articles of Association provides that every Director shall be indemnified out of the assets of the Company against any liability, action, proceeding, claim, demand, costs, damages or expenses, including legal expenses, whatsoever which they or any of them may incur as a result of any act or failure to act in carrying out their functions other than such liability (if any) that they may incur by reason of their own actual fraud or willful defaults. The Company has arranged for appropriate insurance coverage in respect of potential legal actions against its Directors and Senior Management during the year ended December 31, 2021 and as of the date of this report.

PRINCIPAL SUBSIDIARIES

The Group's operations are conducted on a global basis through its direct or indirect subsidiaries. Details of the subsidiaries of the Company as at December 31, 2021 are set out in note 35 to the Consolidated Financial Statements.

MAJOR CUSTOMERS AND SUPPLIERS

During the year ended December 31, 2021, the percentages of purchases attributable to the Group's major suppliers are as follows:

- the largest supplier: 9%
- five largest suppliers in aggregate: 30%

During the year ended December 31, 2021, the percentages of revenue attributable to the Group's major customers are as follows:

- the largest customer: 32%
- five largest customers in aggregate: 85%

As far as the Company is aware, none of the Directors nor any of his associates and none of the shareholders possessing over 5% of the interest in the share capital of the Company possessed any interests in the abovementioned suppliers and customers.

SHARE OPTION SCHEME

Pursuant to an ordinary resolution passed on June 5, 2014, the Company adopted a share option scheme (the **Share Option Scheme**).

1. Purpose

The purposes of the Share Option Scheme are: (1) to align the interests of the Company's Directors and Senior Management with the Company's performance and strategic objectives so as to lay a foundation for the Company's future development and maximise the shareholders' value and (2) to attract, retain and motivate employees in key positions required for attaining the Company's strategic objectives by offering competitive general remuneration in the human resources market.

Directors' Report

2. Participants

The Board may, at their discretion, invite any Directors (excluding Independent non-Executive Directors), Senior Management, as well as other key employees approved by the Board (which means those who are responsible for the decision-making, operation and management of the Company) as the Participants (as defined under the Share Option Scheme).

3. Maximum number of shares subject to Options (as defined under the Share Option Scheme)

- (a) The shares which may be issued upon exercise of all Options to be granted under the Share Option Scheme and any other share option scheme(s) adopted by the Company (and to which the provisions of Chapter 17 of the Listing Rules are applicable) must not in aggregate exceed 249,780,400 shares (the **Scheme Mandate Limit**), representing approximately 9.95% of the issued share capital of the Company as at the date of this report.
- (b) The Company may refresh the Scheme Mandate Limit at any time subject to prior approval of the shareholders in a general meeting and/or such other requirements prescribed under the Listing Rules from time to time. However, the Scheme Mandate Limit as refreshed shall not exceed 10% of the shares in issue as at the date of the aforesaid approval by the shareholders in a general meeting. Options previously granted under the Share Option Scheme and any other share option schemes of the Company (and to which the provisions of Chapter 17 of the Listing Rules are applicable) (including those outstanding, cancelled or lapsed in accordance with its terms or exercised), shall not be counted for the purpose of calculating the limit as refreshed.
- (c) The Company may also seek separate approval of the shareholders in a general meeting to grant Options beyond the Scheme Mandate Limit to Participants specifically identified by the Company before the aforesaid shareholders' meeting at which such approval is sought.
- (d) Subject to the requirements of the Listing Rules, the number of securities may be issued upon the exercise of all outstanding Options granted under the Share Option Scheme and any other schemes shall not exceed 30% of the relevant class of securities in issue of the Company (or its related subsidiaries) from time to time.
- (e) Unless approved by the shareholders in the manner set out in this paragraph, the total number of Shares issued and to be issued upon exercise of the Options granted and to be granted under the Share Option Scheme of the Company to each Participant (including both exercised and outstanding Options) in any 12-month period shall not exceed 1% of the total number of Shares in issue (the **Individual Limit**). Any further grant of Options to a Participant which would result in the Shares issued and to be issued upon exercise of all Options granted and to be granted to such Participant (including exercised, cancelled and outstanding Options) in the 12-month period up to and including the date of such further grant exceeding the Individual Limit shall be subject to separate approval of the shareholders in a general meeting with such Participant and his associates abstaining from voting.
- (f) Each grant of Options to any Director, Chief Executive Officer of the Company (**Chief Executive** or **Chief Executive Officer**) or substantial shareholder of the Company (or any of their respective associates) shall be subject to the prior approval of the Independent non-Executive Directors of the Company. Where any grant of Options to a substantial shareholder, or any of its respective associates, would result in the number of shares issued and to be issued upon exercise of all Options already granted and to be granted (including Options exercised, cancelled and outstanding) to such person in the 12 month period up to and including the date of such grant:
 - (i) Representing in aggregate over 0.1% (or such other higher percentage as may from time to time be specified by the Hong Kong Stock Exchange) of the shares in issue; and

Directors' Report

- (ii) Having an aggregate value, based on the closing price of the Shares as stated in the daily quotations sheet issued by the Hong Kong Stock Exchange on the date on which the Board resolves to make an Offer (as defined under the Share Option Scheme) of that Option to the Participant or such other date as designated by the Board (the **Date of Grant**), in excess of HK\$5 million (or such other higher amount as may from time to time be specified by the Hong Kong Stock Exchange), such further grants of Options shall be subject to the prior approval by the shareholders (voting by way of poll) in a general meeting. The Company shall send a circular to the shareholders in accordance with the Listing Rules and all connected persons (as defined in the Listing Rules) of the Company shall abstain from voting in favour of the resolution at such general meeting.

4. Acceptance period

A Share Option may be accepted by a Participant within a certain number of days from the date of the offer of the grant of the Option as indicated in the offer.

5. Exercise period

The period within which the Options may be exercised must expire no later than 10 years from the relevant Date of Grant.

6. Minimum holding period

The Option must be held for one year from the Date of Grant before it can be exercised. The vesting period shall be three years and one-third shall be vested at each anniversary from the Date of Grant.

7. Consideration for acceptance

The consideration payable for acceptance of the Option of grant by each Participant is HK\$1.00. If the Participant does not accept such grant of Option pursuant to the procedures specified in the respective grant agreement or notice within the stipulated timeframe, such Option shall be regarded as unaccepted and lapsed.

8. Subscription Price

The Subscription Price (as defined under the Share Option Scheme) shall be such price determined by the Board in its absolute discretion and notified to the Participant in the Offer and shall be no less than the higher of:

- (a) the closing price of a share as stated in the daily quotations sheet issued by the Hong Kong Stock Exchange on the Date of Grant;
- (b) the average closing price of the shares as stated in the daily quotations sheet issued by the Hong Kong Stock Exchange for the five business days immediately preceding the Date of Grant; or
- (c) the nominal value of a share.

- 9. The Share Option Scheme will remain in force for a period of 10 years commencing on the date on which the Share Option Scheme was adopted and has a remaining term of approximately 2 years as at the date of this report.

Directors' Report

The summary of the Options granted under the Share Option Scheme that were still outstanding as at December 31, 2021 are as follows (there were no Options granted during the year ended December 31, 2021):

Grant date	Options Granted	Options held at January 1, 2021	Options granted during the year	Options exercised during the year	Options cancelled/lapsed during the year	Options held at December 31, 2021	Exercise period ⁽¹⁾	Exercise price per share (HK\$)	Share price on the grant date ⁽²⁾ (HK\$)	Share price on the exercise date (HK\$)	Weighted average closing price of the Company's shares immediately before the exercise date (HK\$)	
Director												
ZHAO, Guibin	June 11, 2014	1,667,970	1,667,970	-	1,050,000	-	617,970	June 11, 2014 – June 10, 2024	5.150	5.150	10.172	9.680
	June 10, 2015	1,667,970	1,667,970	-	-	-	1,667,970	June 10, 2015 – June 9, 2025	8.610	8.480	N/A	N/A
	June 10, 2016	1,667,970	1,111,980	-	-	-	1,111,980	June 10, 2016 – June 9, 2026	7.584	7.340	N/A	N/A
	May 29, 2017	1,667,970	555,990	-	-	-	555,990	May 29, 2017 – May 28, 2027	11.620	11.620	N/A	N/A
	May 30, 2018	1,667,970	1,111,980	-	-	555,990	555,990	May 30, 2018 – May 29, 2028	12.456	11.960	N/A	N/A
	August 21, 2019	1,667,970	1,111,980	-	-	555,990	555,990	August 21, 2019 – August 20, 2029	6.390	6.390	N/A	N/A
MILAVEC, Robin Zane	May 30, 2018	526,730	351,150	-	-	175,570	175,580	May 30, 2018 – May 29, 2028	12.456	11.960	N/A	N/A
	August 21, 2019	1,667,970	1,111,980	-	-	555,990	555,990	August 21, 2019 – August 20, 2029	6.390	6.390	N/A	N/A
FAN, Yi	June 11, 2014	526,730	526,730	-	-	-	526,730	June 11, 2014 – June 10, 2024	5.150	5.150	N/A	N/A
	June 10, 2015	526,730	526,730	-	-	-	526,730	June 10, 2015 – June 9, 2025	8.610	8.480	N/A	N/A
	June 10, 2016	526,730	351,160	-	126,000	-	225,160	June 10, 2016 – June 9, 2026	7.584	7.340	10.233	10.400
	May 29, 2017	526,730	175,580	-	-	-	175,580	May 29, 2017 – May 28, 2027	11.620	11.620	N/A	N/A
	May 30, 2018	526,730	351,150	-	-	175,570	175,580	May 30, 2018 – May 29, 2028	12.456	11.960	N/A	N/A
	August 21, 2019	526,730	351,150	-	-	175,580	175,570	August 21, 2019 – August 20, 2029	6.390	6.390	N/A	N/A
LIU, Ping ⁽³⁾	August 21, 2019	351,150	234,100	-	-	234,100	-	August 21, 2019 – August 20, 2029	6.390	6.390	N/A	N/A
WANG, Jian	August 21, 2019	702,300	468,200	-	-	234,100	234,100	August 21, 2019 – August 20, 2029	6.390	6.390	N/A	N/A
Sub-total		16,416,350	11,675,800	-	1,176,000	2,662,890	7,836,910					
All Other Participants (in aggregate)												
	June 11, 2014	9,042,160	351,150	-	351,150	-	-	June 11, 2014 – June 10, 2024	5.150	5.150	11.420	10.960
	June 10, 2015	8,164,290	526,720	-	351,150	-	175,570	June 10, 2015 – June 9, 2025	8.610	8.480	10.877	10.060
	June 10, 2016	8,407,790	1,031,700	-	401,160	-	630,540	June 10, 2016 – June 9, 2026	7.584	7.340	12.391	11.905
	May 29, 2017	9,724,610	1,146,840	-	-	-	1,146,840	May 29, 2017 – May 28, 2027	11.620	11.620	N/A	N/A
	May 30, 2018	10,251,340	3,907,940	-	-	1,953,950	1,953,990	May 30, 2018 – May 29, 2028	12.456	11.960	N/A	N/A
	August 21, 2019	8,758,950	3,498,260	-	-	2,305,150	1,193,110	August 21, 2019 – August 20, 2029	6.390	6.390	N/A	N/A
Sub-total		54,349,140	10,462,610	-	1,103,460	4,259,100	5,100,050					
Total		70,765,490	22,138,410	-	2,279,460	6,921,990	12,936,960					

Directors' Report

Notes:

- (1) The Options granted in 2014, 2015, 2016, 2017, 2018 and 2019 must be held for one year from June 11, 2014, June 10, 2015, June 10, 2016, May 29, 2017, May 30, 2018 and August 21, 2019, respectively. The Options are exercisable subject to, amongst other relevant vesting criteria, the vesting schedule of one-third at each anniversary of the Date of Grant of the share option.
- (2) The exercise price for the Options granted on June 11, 2014, May 29, 2017 and August 21, 2019 was the closing price of the shares quoted on the Hong Kong Stock Exchange on the trading day on the Date of Grant of the Options. The exercise price for the Options granted on June 10, 2015, June 10, 2016 and May 30, 2018 was the average closing price for five consecutive trading days prior to the Date of Grant of the Options.
- (3) Mr. LIU, Ping retired as our non-Executive Director with effect from June 8, 2021.

PENSION SCHEMES

The Group has both defined contribution and defined benefit plans. Various subsidiaries within the Group operate various pension schemes. The schemes are generally funded through payments to insurance companies or trustee administered funds, determined by periodic actuarial calculations.

More detailed information regarding pension schemes is set out in note 17 to the Consolidated Financial Statements.

NON-COMPETITION UNDERTAKING FROM OUR CONTROLLING SHAREHOLDERS

On June 15, 2013, each of AVIC, AVIC Auto, PCM China and Nexteer Hong Kong (together the **Controlling Shareholders**) provided a non-competition undertaking (the **Non-competition Undertaking**), pursuant to which each of the Controlling Shareholders has unconditionally and irrevocably undertaken that apart from the Retained Business as defined in the prospectus of the Company dated September 24, 2013 (the **Prospectus**) it will not, and will procure its subsidiaries not to, whether directly or indirectly through third parties or the provision of support to such third parties, engage in any automotive steering systems and driveline systems business (the **Core Business**) that competes, or is likely to compete, directly or indirectly with our Group. Details of the Non-competition Undertaking were disclosed in the Prospectus under the section headed 'Relationship with our Controlling Shareholders'.

On August 21, 2020, Yubei Steering Systems (Xinxiang) Co., Ltd. (formerly known as Yubei Steering Systems Co., Ltd.) (**Yubei Steering**) notified the Company in writing that AVIC has approved the transfer of the 24.93% equity interest in Yubei Steering. Pursuant to the Non-competition Undertaking, the Company can exercise the pre-emptive right of first refusal to acquire such interest. As of August 31, 2020, the Independent non-Executive Directors had resolved that the Company would not exercise the pre-emptive right of first refusal to acquire the 24.93% equity interest in Yubei Steering. For details, please refer to the announcement of the Company dated September 8, 2020.

For the year ended December 31, 2021, the Group has not (1) pursued or declined any new business opportunity referred to us by the Controlling Shareholders nor (2) exercised or waived the pre-emptive rights under the Non-competition Undertaking. Certain Controlling Shareholders have provided an annual confirmation of its compliance with the Non-competition Undertaking. The Independent non-Executive Directors have reviewed and were satisfied that such Controlling Shareholders have complied with the Non-competition Undertaking for the year ended December 31, 2021.

Directors' Report

CONTROLLING SHAREHOLDERS' INTERESTS IN CONTRACTS

There were no contracts of significance (including for the provision of services) with any member of the Group as the contracting party and in which any of the Controlling Shareholders possessed direct or indirect substantial interests, and which was still valid on December 31, 2021 or any time during such year and related to the business of the Group.

DIRECTORS' AND CHIEF EXECUTIVE'S INTERESTS AND SHORT POSITIONS IN THE SHARE AND UNDERLYING SHARES

As at December 31, 2021, the interests or short positions of the Directors or Chief Executive of the Company in the Shares, underlying Shares and debentures of the Company or its associated corporations (within the meaning of Part XV of the Securities and Futures Ordinance (the **SFO**)) required to be notified to the Company and the Hong Kong Stock Exchange pursuant to Divisions 7 and 8 of Part XV of the SFO (including interest or short positions which they were taken or deemed to have under such provisions of the SFO), or which would be required, pursuant to section 352 of the SFO, to be entered in the register referred to therein, or which would be required to be notified to the Company and the Hong Kong Stock Exchange pursuant to the Model Code for Securities Transactions by Directors of Listed Issuers set out in Appendix 10 to the Listing Rules (the **Model Code**) are as follows:

Interest in the Company

Name	Capacity	Nature of interest	No. of underlying Shares of the Company held ⁽¹⁾	Approximate percentage of total issued Shares ⁽²⁾
ZHAO, Guibin	Director and Chief Executive Officer	Beneficial owner	5,065,890 (L)	0.20%
FAN, Yi	Director	Beneficial owner	1,805,350 (L)	0.07%
MILAVEC, Robin Zane	Director	Beneficial owner	731,570 (L)	0.03%
WANG, Jian	Director	Beneficial owner	234,100 (L)	0.01%

Notes:

(L) Denotes a long position in Shares.

(1) These represent the interests in underlying Shares in respect of the Options granted by the Company.

(2) The calculation is based on the total number of shares in issue as at December 31, 2021 of 2,509,824,293.

Except as disclosed above, as at December 31, 2021, none of our Directors and Chief Executive of the Company have any interests or short positions in the Shares, underlying Shares or debentures of the Company or its associated corporations (within the meaning of Part XV of the SFO) which were (i) recorded in the register required to be kept under section 352 of the SFO or (ii) otherwise notified to the Company and the Hong Kong Stock Exchange pursuant to the Model Code.

DIRECTORS' RIGHTS TO ACQUIRE SHARES OR DEBENTURES

Except as disclosed above, no rights to acquire benefits by means of the acquisition of Shares in or debentures of the Company or any of its subsidiaries were granted to any Director or their respective spouse or children under 18 years of age, nor were any such rights exercised by them. Neither the Company nor any of its subsidiaries was a party to any arrangement to enable the Directors, or their respective spouse or children under 18 years of age, to acquire such rights in any other body corporate for the year ended December 31, 2021.

SUBSTANTIAL SHAREHOLDERS' INTERESTS AND SHORT POSITIONS IN THE SHARES AND UNDERLYING SHARES

As at December 31, 2021, the following shareholders (excluding the Directors and Chief Executive of the Company) had interests or short positions in any Shares and underlying Shares of the Company which will be required to be disclosed under provisions of Division 2 and 3 of Part XV of the SFO as recorded in the register required to be kept under Section 336 of the SFO:

Name	Capacity	No. of Shares	Approximate percentage of total Issued Shares ⁽¹⁾
Nexteer Automotive (Hong Kong) Holdings Limited (Nexteer Hong Kong) ⁽²⁾	Beneficial Owner	1,630,000,000 (L)	64.94%
Pacific Century Motors, Inc. (PCM China) ⁽²⁾	Interest of controlled corporation	1,630,000,000 (L)	64.94%
AVIC Automotive Systems Holding Co., Ltd. (AVIC Auto) ⁽³⁾	Interest of controlled corporation	1,630,000,000 (L)	64.94%
Aviation Industry Corporation of China, Ltd. (AVIC) ⁽³⁾	Interest of controlled corporation	1,630,000,000 (L)	64.94%

Notes:

(L) Denotes a long position in Shares.

(1) The calculation is based on the total number of 2,509,824,293 Shares in issue as at December 31, 2021.

(2) Nexteer Hong Kong is wholly-owned by PCM China, which is in turn owned as to 51% by AVIC Auto and as to 49% by Beijing E-Town International Automotive Investment & Management Co., Ltd. (北京亦莊國際汽車投資管理有限公司) (a directly wholly-owned subsidiary of Beijing E-Town International Investment & Development Co. Ltd). Each of PCM China and AVIC Auto is deemed to be interested in the 1,630,000,000 Shares held by Nexteer Hong Kong.

(3) AVIC Auto is owned as to 70.11% by AVIC. AVIC is deemed to be interested in the 1,630,000,000 Shares held by Nexteer Hong Kong.

Directors' Report

DISCLOSURE OF INTERESTS OF SUBSTANTIAL SHAREHOLDERS OF OTHER MEMBERS OF OUR GROUP

So far as our Directors are aware, as at December 31, 2021, the persons other than our Directors and our Chief Executive who were directly interested in 10% or more of the issued and outstanding share capital of our subsidiaries carrying rights to vote in all circumstances at general meetings of each relevant subsidiary, were as follows:

Member of our Group	Person with 10% or more interest (other than the Company)	Capacity	Percentage of the substantial shareholder's interest
Nexteer Lingyun Driveline (Zhuozhou) Co., Ltd.	Lingyun Industrial Corp., Ltd.	Registered owner	40%
Nexteer Lingyun Driveline (Wuhu) Co., Ltd.	Lingyun Industrial Corp., Ltd.	Registered owner	40%
Chongqing Nexteer Steering Systems Co., Ltd.	Chongqing Jianshe Industry (Group) Co., Ltd.	Registered owner	50%
CNXMotion, LLC	Continental Automotive Systems, Inc.	Registered owner	50%
Dongfeng Nexteer Steering Systems (Wuhan) Co., Ltd.	Dongfeng Motor Parts and Components (Group) Co., Ltd.	Registered owner	50%

Except as disclosed above, as at December 31, 2021, our Directors are not aware of any person who, as at December 31, 2021, was, directly or indirectly, interested in 10% or more of the nominal value of any class of share capital carrying voting rights to vote in all circumstances at general meetings of any other member of our Group.

CONNECTED TRANSACTIONS

The Group's related parties transactions for the year ended December 31, 2021 set out in note 31 to the Consolidated Financial Statements did not constitute connected transactions or continuing connected transactions (as defined in Chapter 14A of the Listing Rules).

PURCHASE, REDEMPTION OR SALE OF LISTED SECURITIES OF THE COMPANY

For the year ended December 31, 2021, neither the Company nor any of its subsidiaries purchased, redeemed or sold any of the Company's listed securities.

MANAGEMENT CONTRACTS

No contracts concerning the management and administration of the whole or any substantial part of the business of the Group were entered into or existed for the year ended December 31, 2021.

PUBLIC FLOAT

Based on information that is publicly available to the Company and within the knowledge of the Directors as at the latest practicable date prior to the issue of the annual report, the Company has maintained the public float as required by the Listing Rules up to the date of this annual report.

PROFESSIONAL TAX ADVICE RECOMMENDED

If the shareholders of the Company are unsure about the taxation implications of purchasing, holding, disposing of, dealing in or the exercise of any rights in relation to the Shares of the Company, they are advised to consult an expert.

AUDITOR

The Consolidated Financial Statements have been audited by Deloitte Touche Tohmatsu, the Company's external auditor.

The Consolidated Financial Statements for the years ended December 31, 2019 and 2020 have been audited by PricewaterhouseCoopers. On June 8, 2021 PricewaterhouseCoopers retired as auditor of the Company and Deloitte Touche Tohmatsu was appointed as auditor of the Company following the retirement of PricewaterhouseCoopers.

CLOSURE OF REGISTER OF MEMBERS

The Company's AGM will be held on June 21, 2022. For determining the entitlement to attend and vote at the AGM, the register of members of the Company will be closed from June 16, 2022 to June 21, 2022, both days inclusive, during which period no transfer of Shares will be registered. In order to be eligible to attend and vote at the AGM, all transfers accompanied by the relevant share certificates must be lodged with the Company's Share Registrar in Hong Kong, Computershare Hong Kong Investor Services Limited at Shops 1712-1716, 17th Floor, Hopewell Centre, 183 Queen's Road East, Wanchai, Hong Kong for registration no later than 4:30 p.m. on June 15, 2022.

The final dividend is payable on July 11, 2022 and the record date for entitlement to the proposed final dividend is June 29, 2022. For determining the entitlement to the proposed final dividend, the register of members of the Company will be closed from June 27, 2022 to June 29, 2022, both days inclusive, during which no transfer of Shares will be registered. In order to qualify for the proposed final dividend, all transfers accompanied by the relevant share certificates must be lodged with the Company's Share Registrar in Hong Kong, Computershare Hong Kong Investor Services Limited (address as per above) for registration no later than 4:30 p.m. on June 24, 2022.

On behalf of the Board

FAN, Yi

Executive Director and Company Secretary

Hong Kong, March 16, 2022

Corporate Governance Report

CORPORATE GOVERNANCE PRACTICES

The Company is committed to maintaining high standards of corporate governance. The Company recognises that sound corporate governance practices are fundamental to our effective and transparent operation and to the Group's ability to protect the rights of the Shareholders and enhance shareholder value.

The Company has adopted its own Internal Control and Corporate Governance Policies, which are based on the principles, provisions and practices set out in the Corporate Governance Code (the **Hong Kong CG Code**) contained in Appendix 14 to the Listing Rules.

In the opinion of the directors of the Board (the **Directors**), the Company has complied with all applicable code provisions set out in the Hong Kong CG Code and all applicable laws and regulations that have a significant impact on the business and operation of the Group throughout the year ended December 31, 2021.

The Company periodically reviews its corporate governance practices with reference to the latest developments of the Hong Kong CG Code.

CHAIRMAN AND CHIEF EXECUTIVE OFFICER

Under the code provision in C.2.1 in Part 2 of the Hong Kong CG Code, the roles of chairman and chief executive officer should be separate and should not be performed by the same individual. The chairman of the Board and the Chief Executive Officer are currently two separate positions held by Mr. LEI, Zili as the Chairman of the Board and Mr. ZHAO, Guibin as Chief Executive Officer, with clear distinction in responsibilities. Mr. LEI replaced Mr. WANG, Jian as Chairman of the Board with effect from March 16, 2022. The Chairman of the Board is responsible for providing overall strategic planning and business development of the Group, while the Chief Executive Officer is responsible for general business operation and the implementation of overall business strategy.

COMPLIANCE WITH CODE OF CONDUCT REGARDING DIRECTORS' SECURITIES TRANSACTIONS

The Company has adopted the Model Code as set out in Appendix 10 to the Listing Rules as the Company's code of conduct regarding securities transactions by the Directors of the Company. Having made specific enquiry of all Directors, all Directors have confirmed that they complied with the required standards set out in the Model Code for the year ended December 31, 2021.

The Company has also adopted its own code of conduct regarding employees' securities transactions in terms no less exacting than the standard set out in the Model Code for the compliance by its relevant employees who are likely to be in possession of unpublished inside information of the Company in respect of their dealings in the Company's securities.

The Company maintains and regularly reviews a sensitivity list identifying factors or developments which are likely to give rise to the emergence of inside information or development of a false market for its securities.

The Company ensures that confidentiality agreements are signed by all relevant parties to a transaction that is likely to give rise to the emergence of inside information or development of a false market for its securities. The Company also adopts appropriate measures to maintain the confidentiality of the information, such as using project codes and restricting access to such information to a limited group of recipients on a need-to-know basis.

The Company organises periodic training as it deems necessary for employees who, because of their office or employment, are likely to be in possession of inside information in relation to the Company, to help them understand the Company's policies and procedures as well as their relevant disclosure duties and obligations.

THE BOARD OF DIRECTORS AND SENIOR MANAGEMENT

The Board is responsible for leadership and control of the Company and the Group and for promoting the success of the Group by directing and supervising the Group's affairs. In addition, the Board is responsible for overseeing ESG issues. The Board is also responsible for overseeing the corporate governance and financial reporting of the Company and for reviewing the effectiveness of the Group's system of internal control and risk management. To assist it in fulfilling its duties, the Board has established two board committees: the Audit and Compliance Committee and the Remuneration and Nomination Committee.

The Group is managed collectively by our core management team, which is comprised of the Board and Senior Management of the Group. Members of our Senior Management are responsible for overseeing their respective divisions and functions and making day-to-day decisions of the Group. They meet regularly to discuss issues of their respective functions and make relevant decisions and report to our Board regularly and when necessary. Our Senior Management as a whole is also responsible for formulating the overall strategies, annual budget, key business, financial and other operational policies and preparing proposals of any key business, financial and other operational decisions of the Group taking into account inputs from different functions for the Board's approval. The Board will consult with our Senior Management on such proposals and discuss the same at the Board level with an aim to reach a consensus that is in the best interest of the Group. Once the key policies and decisions are formulated and made, our Senior Management as a whole will implement the same throughout the Group. Accordingly, the overall strategic and other key business, financial and operational policies and decisions of the Group are made collectively from its inception to implementation after thorough discussion at both Board and Senior Management levels.

The Board has established clear guidelines with respect to matters that must be approved or recommended by the Board, including, without limitation, approval and adoption of the Group's annual operating budget and capital expenditure budget; the hiring or dismissal of the Chief Executive Officer, Chief Financial Officer (the **CFO**), Company Secretary or certain other members of the Senior Management team; and approving and recommending significant transactions. The Group has arranged for appropriate insurance coverage in respect of potential legal actions against its Directors and Senior Management.

Composition of the Board, Number of Board Meetings and Directors' Attendance

As at December 31, 2021, the Board consists of nine Directors, including three Executive Directors, namely ZHAO, Guibin (Vice Chairman), MILAVEC, Robin Zane and FAN, Yi, three non-Executive Directors namely WANG, Jian (resigned as Chairman with effect from March 16, 2022), ZHANG, Wendong and LEI, Zili (Chairman) (appointed as Director with effect from June 8, 2021 and as Chairman with effect from March 16, 2022) and three Independent non-Executive Directors, namely LIU, Jianjun, WEI, Kevin Cheng and YICK, Wing Fat Simon. The biographical details of each current Director and their respective responsibilities and dates of appointment are included in the section headed 'Directors and Senior Management' of this annual report. None of the Directors or chief executive is related to one another.

Corporate Governance Report

The following is the attendance record of the Directors at the Board and committee meetings, and the annual general meeting held for the year ended December 31, 2021:

Name of Director	Attendance/number of Meetings in 2021			
	Board	Remuneration and Nomination Committee	Audit and Compliance Committee	Annual General Meeting
ZHAO, Guibin (趙桂斌)	4/4	N/A	N/A	1/1
MILAVEC, Robin Zane	4/4	N/A	N/A	1/1
FAN, Yi (樊毅)	4/4	N/A	N/A	1/1
WANG, Jian (王堅)	2/4	N/A	N/A	1/1
ZHANG, Wendong (張文冬)	4/4	3/3	N/A	1/1
LIU, Ping (劉平) ⁽¹⁾	0/1	N/A	0/1	N/A
Mr. LEI, Zili (雷自力) ⁽²⁾	3/3	N/A	2/2	N/A
LIU, Jianjun (劉健君)	4/4	3/3	N/A	1/1
WEI, Kevin Cheng (蔚成)	4/4	N/A	3/3	1/1
YICK, Wing Fat Simon (易永發)	4/4	3/3	3/3	1/1

Notes:

- (1) Mr. LIU, Ping retired as our non-Executive Director with effect from June 8, 2021 due to personal work adjustment.
- (2) Mr. LEI, Zili (雷自力) was appointed as our non-Executive Director with effect from June 8, 2021 and as Chairman of the Board with effect from March 16, 2022.

PRACTICES AND CONDUCT OF MEETINGS

Notice of regular Board meetings is given to all Directors at least 14 days in advance, and reasonable notice is generally given for other Board meetings. Annual meeting schedules and the draft agenda of each meeting are normally made available to Directors in advance. Arrangements are in place to allow Directors to include items in the agenda, and final agendas together with relevant supporting documents are sent to Directors at least 3 days before each regular Board meeting, and as soon as practicable before other Board meetings, so that the Board can make informed decisions on matters placed before it. Each Director also has separate and independent access to the Senior Management where necessary. Minutes of the Board meetings are kept by the Company Secretary. Draft minutes are circulated to Directors for comment within a reasonable time after each meeting.

If a Director or any of their associates has a material interest in a transaction, that Director is required to abstain from voting and not to be counted in the quorum at the meeting for approving the transaction.

INDEPENDENCE OF INDEPENDENT NON-EXECUTIVE DIRECTORS

During the year ended December 31, 2021, the Board met the requirements of the Listing Rules relating to the appointment of at least three Independent non-Executive Directors representing one-third of the Board with one of whom possessing appropriate professional qualifications or accounting or related financial management expertise.

The Company has received written confirmation from each of the Independent non-Executive Directors in respect of his independence in accordance with the independence guidelines set out in Rule 3.13 of the Listing Rules. The Company considers all Independent non-Executive Directors to be independent.

Corporate Governance Report

APPOINTMENT AND RE-ELECTION OF DIRECTORS

The Company uses a formal and transparent procedure for the appointment, election and removal of Directors, which is set out in the Company's Articles of Association and is led by the Remuneration and Nomination Committee, which will make recommendations on appointment of new Directors to the Board for approval.

Further details relating to the appointment, election and removal of Directors and the service contracts of Directors are set out in the sections headed 'Directors' and 'Service Contracts of Directors' in the Directors' Report included in this annual report.

CONTINUOUS PROFESSIONAL DEVELOPMENT OF DIRECTORS

Each newly appointed Director receives a comprehensive introduction to the Company in order to ensure his understanding of the business and operations of the Group and awareness of a director's responsibilities and obligations. All Directors are encouraged to participate in continuous professional development to develop and refresh their knowledge by attending internal training and external seminars. For the year ended December 31, 2021, the Company arranged in-house training for all Directors relating to on-going compliance obligations, corporate governance and other related topics. In compliance with Rule 3.29 of the Listing Rules, Mr. FAN, Yi, our Executive Director and Company Secretary, has undertaken not less than 15 hours of relevant professional training during the year ended December 31, 2021.

During the year ended December 31, 2021, the Directors participated in the following training:

Directors	Types of training
Executive Directors	
ZHAO, Guibin (<i>Vice Chairman</i>)	A, C, D
MILAVEC, Robin Zane	A, B, C, D
FAN, Yi	A, C, D
Non-Executive Directors	
WANG, Jian	A, B, C, D
LIU, Ping (retired with effect from June 8, 2021)	A, C, D
ZHANG, Wendong	A, B, C, D
LEI, Zili (<i>Chairman</i>) (appointed as non-Executive Director with effect from June 8, 2021 and as Chairman with effect from March 16, 2022)	A, B, C, D
Independent Non-Executive Directors	
LIU, Jianjun	A, C, D
WEI, Kevin Cheng	A, C, D
YICK, Wing Fat Simon	A, C, D

A: attending seminars and/or conferences and/or forums

B: giving talks at seminars and/or conferences and/or forums

C: attending in-house training relating to the on-going compliance obligations, corporate governance and other related topics

D: reading newspapers, journals, Company's newsletters and updates relating to the economy, general business, automotive component manufacturing industry or Directors' duties and responsibilities, etc.

COMMITTEES

The Board has established the Audit and Compliance Committee, and the Remuneration and Nomination Committee for overseeing particular aspects of the Group's affairs. All Board committees are established with defined written terms of reference which are posted on the Company's website, the Hong Kong Stock Exchange's website and are available to shareholders upon request. Meetings of the Board committees generally follow the same procedures as meetings of the Board.

Corporate Governance Report

THE AUDIT AND COMPLIANCE COMMITTEE

The Board established the Audit and Compliance Committee on June 15, 2013 and had provided clear written terms of reference as required by code provision in C.4.1 in Part 2 of the Hong Kong CG Code. The terms of reference (as revised on March 12, 2019) are in compliance with Rule 3.21 of the Listing Rules and code provisions D.3.3 and A.2.1 in Part 2 of the Hong Kong CG Code. The Audit and Compliance Committee consists of Mr. WEI, Kevin Cheng, Mr. YICK, Wing Fat Simon, Mr. LIU, Ping (retired with effect from June 8, 2021), Mr. LEI, Zili (appointed with effect from June 8, 2021 and resigned with effect from March 16, 2022) and Mr. WANG, Jian (appointed with effect from March 16, 2022). All members of the Audit and Compliance Committee are non-Executive Directors, among whom Mr. WEI, Kevin Cheng and Mr. YICK, Wing Fat Simon are Independent non-Executive Directors. The chairman of the Audit and Compliance Committee is Mr. WEI, Kevin Cheng who holds the appropriate professional qualifications as required under Rules 3.10(2) and 3.21 of the Listing Rules. The primary duties of the Audit and Compliance Committee include, without limitation, assisting our Board by providing an independent view of the effectiveness of the financial reporting process, risk management and internal control system of the Group, overseeing the audit process and performing other duties and responsibilities as assigned by the Board.

The Board recognises that corporate governance should be the collective responsibility of the Directors and delegates the corporate governance duties to the Audit and Compliance Committee which include:

- reviewing and monitoring the Group's policies and practices on compliance with legal and regulatory requirements;
- developing, reviewing and monitoring the code of conduct and compliance manual (if any) applicable to employees and Directors;
- developing and reviewing the Company's policies and practices on corporate governance and making recommendations to the Board and report to the Board on matters;
- reviewing the Company's compliance with the Hong Kong CG Code and disclosure in the Corporate Governance Report; and
- considering any other topics, as determined by the Board.

There were three meetings of the Audit and Compliance Committee held for the year ended December 31, 2021, the attendance record of the committee members is set out above. The following is a summary of the major work performed by the Audit and Compliance Committee during 2021:

- reviewed the reports and findings from management including Internal Audit on the implementation and refinement of the risk management and internal control measures;
- reviewed the Internal Audit plan;
- confirmed the independence and objectivity of the Company's external auditor, Deloitte Touche Tohmatsu;
- met with the external auditor and reviewed their 2021 audit plan;
- reviewed the annual results and the adequacy of the risk management and internal control system for the year ended December 31, 2021; and
- reviewed the interim results for the six months ended June 30, 2021.

Subsequent to December 31, 2021 and up to the date of this annual report, a meeting of the Audit and Compliance Committee was held on March 15, 2022 to review the annual results and the adequacy of the risk management and internal control system for the year ended December 31, 2021.

THE REMUNERATION AND NOMINATION COMMITTEE

The Board established the Remuneration and Nomination Committee on June 15, 2013 and had provided clear written terms of reference as required by code provision in C.4.1 in Part 2 of the Hong Kong CG Code. The terms of reference (as revised on August 15, 2017) are in compliance with code provisions B.3.1 and E.1.2 in Part 2 of the Hong Kong CG Code. These terms of reference include appropriate professional knowledge and industry experience, personal ethics, integrity and personal skill as well as time commitments of members. The Remuneration and Nomination Committee consists of, Mr. LIU, Jianjun, Mr. YICK, Wing Fat Simon, and Ms. ZHANG, Wendong. All members of the Remuneration and Nomination Committee are non-Executive Directors, among whom Mr. YICK, Wing Fat Simon and Mr. LIU, Jianjun are Independent non-Executive Directors. The chairman of the Remuneration and Nomination Committee is Mr. YICK, Wing Fat Simon. The primary functions of the Remuneration and Nomination Committee include, without limitation, (i) making recommendations to the Board on our policy and structure for all remuneration of Directors and Senior Management and on the establishment of a formal and transparent procedure for developing policy on such remuneration; (ii) making recommendations on the remuneration packages of Executive and non-Executive Directors and Senior Management; (iii) reviewing and approving Senior Management's remuneration proposals with reference to corporate goals and objectives resolved by the Board from time to time; (iv) reviewing the structure, size, composition and diversity of the Board; (v) assessing the independence of Independent non-Executive Directors; and (vi) making recommendations to the Board on matters relating to the appointment of Directors.

The remuneration of Directors and Senior Management is determined with reference to their expertise and experience in the industry, the performance and profitability of the Group as well as remuneration benchmarks from other local and international companies and prevailing market conditions. Directors and employees also participate in bonus arrangements which are determined in accordance with the performance of the Group and the individual's performance. No Director or any of their associates takes part in any discussion about their own remuneration.

There were three meetings of the Remuneration and Nomination Committee held for the year ended December 31, 2021, the attendance record of the committee members is set out above. The following is a summary of the major work performed by the Remuneration and Nomination Committee during 2021:

- nominated one non-Executive Director;
- reviewed and made a recommendation to the Board regarding the fees of the Independent non-Executive Directors and the Senior Management;
- reviewed the Board structure, size, composition and board diversity (including ability, knowledge and experience etc.);
- confirmed the independence of the Independent non-Executive Directors; and
- considered the retirement and re-nomination of Directors for re-election at the AGM.

BOARD DIVERSITY POLICY

The Company recognises and embraces the benefits of having a diverse Board to enhance the quality of its performance. To that end, the Company has adopted a Board diversity policy to set out the approach to achieve diversity on the Board. With a view to achieving a sustainable and balanced development, the Company sees increasing diversity at the Board level as an essential element in supporting the attainment of its strategic objectives and its sustainable development. In designing the Board's composition, Board diversity has been considered from a number of aspects, including but not limited to gender, age, ethnicity, years of work experience, and professional experience. All Board appointments will be based on meritocracy, and candidates will be considered against objective criteria, having due regard for the benefits of diversity on the Board. The Company continues to pursue board diversity in multiple aspects, including appointment of a female Director to the Board in 2020. A visual snapshot of the Board's diversity and certain measurable objectives as at December 31, 2021 is shown on this page.

Corporate Governance Report

DIVERSITY SNAPSHOTS

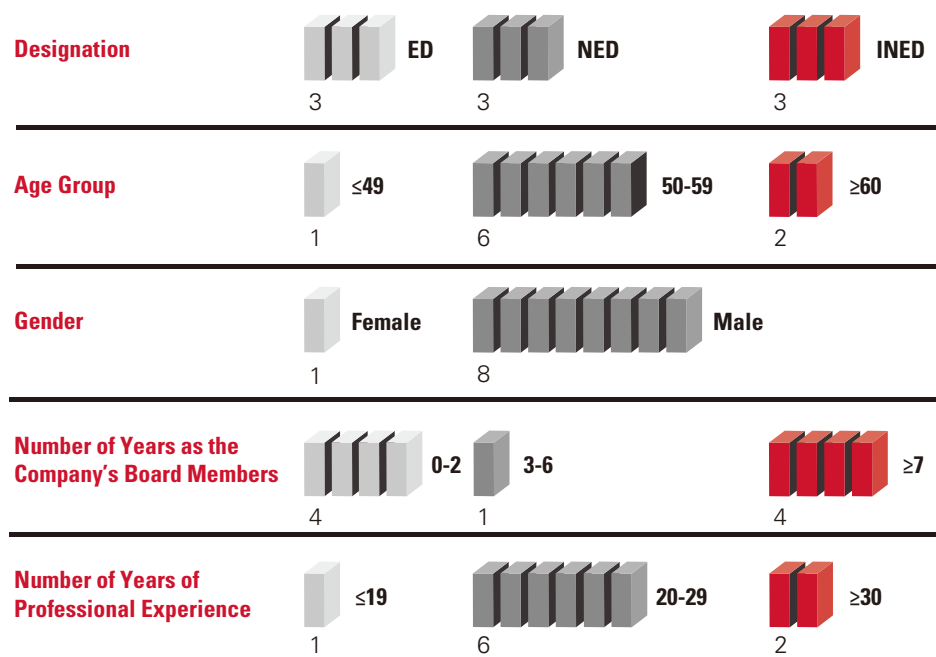

Directors	Professional experiences include
ZHAO, Guibin	automotive, aviation technology, strategy, corporate governance, operation management, economics, business administration
MILAVEC, Robin Zane	automotive, engineering strategy, operations, business administration
FAN, Yi	automotive, company secretary, aviation technology, engineering, economics, management
WANG, Jian	automotive, aviation technology, strategy, corporate governance, operation management, finance, economics
ZHANG, Wendong	investment, strategy, international marketing management, finance, business administration, economics
LEI, Zili	automotive, aviation technology, strategy, business administration
LIU, Jianjun	legal, compensation and compliance
WEI, Kevin Cheng	accounting, auditing, finance, investment banking, corporate finance advisory, real-estate, energy, sports, business administration
YICK, Wing Fat Simon	accounting, auditing, remuneration, investment banking, corporate advisory services, environment, bio-tech, business administration

NOMINATION POLICY

The Remuneration and Nomination Committee shall nominate suitable candidates to the Board for it to consider and make recommendations to shareholders for election as directors of the Company at general meetings or to appoint as directors to fill casual vacancies. The Remuneration and Nomination Committee may, as it considers appropriate, nominate a number of candidates more than the number of directors to be appointed or re-appointed at a general meeting, or the number of casual vacancies to be filled.

The factors listed below would be used as reference by the Remuneration and Nomination Committee in assessing the suitability of a proposed candidate: reputation for integrity and good character; judgment and diversity of experience in all its aspects, including but not limited to gender, age, ethnicity, years of work experience, and professional experience – including educational background, skills and knowledge; commitment to the Company in respect of available time and relevant interest; ability to provide insight in relation to the Company's line of business; requirement for the Board to have independent non-executive directors in accordance with the Listing Rules; whether the candidate would be considered independent with reference to the independence guidelines set out in the Listing Rules, taking into account factors like the candidate's relationship with the existing directors and any substantial interest in the Company; understanding of the fiduciary duties required; and compliance with the Board Diversity Policy and any measurable objectives adopted by the Remuneration and Nomination Committee for achieving diversity on the Board. These factors are for reference only, and not meant to be exhaustive and decisive. The Remuneration and Nomination Committee has the discretion to nominate any person, as it considers appropriate. Proposed candidates will be asked to submit the necessary personal information in a prescribed form, together with their written consent to be appointed as a director and to the public disclosure of their personal data on any documents or the relevant websites for the purpose of or in relation to their standing for election as a director. The Remuneration and Nomination Committee may request candidates to provide additional information and documents, if considered necessary.

The secretary of the Remuneration and Nomination Committee shall call a meeting of the Remuneration and Nomination Committee, and invite nominations of candidates from Board members if any, for consideration by the Remuneration and Nomination Committee prior to its meeting. For filling a casual vacancy, the Remuneration and Nomination Committee shall make recommendations for the Board's consideration and approval. For proposing candidates to stand for election at a general meeting, the Remuneration and Nomination Committee shall make nominations to the Board for its consideration and recommendation. Until the issue of the shareholder circular, the nominated persons shall not assume that they have been proposed by the Board to stand for election at the general meeting. Nomination procedures to be followed by the shareholders shall be in accordance with the Articles of Association (as amended and/or from time to time). A candidate is allowed to withdraw his candidature at any time before the general meeting by serving a notice in writing to the Company Secretary. The Board shall have the final decision on all matters relating to its recommendation of candidates to stand for election at any general meeting.

DIVIDEND POLICY

The declaration of dividends is subject to the discretion of the Board and the approval of the Company's shareholders. Subject to applicable laws and regulations, the Company currently intends to pay dividends of not less than 20% of its net profits available for distribution. The Board may recommend a payment of dividends in the future after taking into account the Company's operations and earnings, capital requirements and surplus, general financial condition, contractual restrictions, capital expenditures and future development requirements, shareholders' interests and other factors which they may deem relevant at such time. Any declaration and payment as well as the amount of the dividends will be subject to the Company's constitutional documents and the Companies Law (as amended) of the Cayman Islands including the approval of the Company's shareholders. Any future declarations of dividends may or may not reflect the Company's historical declarations of dividends and will be at the absolute discretion of the Board.

Corporate Governance Report

AUDITOR'S REMUNERATION

The Company's external auditor is Deloitte Touche Tohmatsu. A breakdown analysis of the remuneration paid to Deloitte Touche Tohmatsu for the year ended December 31, 2021 is set out below. The Audit and Compliance Committee has confirmed the independence and objectivity of the external auditor.

Service Category	Fees Paid US\$'000
Audit Services	1,785
Non-audit Services	208
Total	1,993

Non-audit services include allowable tax consulting and compliance services.

COMPANY SECRETARY

Mr. FAN, Yi had served as the Joint Company Secretary since January 28, 2013 until he became the sole Company Secretary with effect from October 19, 2018. The biographical details of Mr. FAN, Yi are set out under the section headed 'Directors and Senior Management' of this annual report.

During 2021, in accordance with Rule 3.29 of the Listing Rules, Mr. FAN, Yi undertook no less than 15 hours of professional training to update his respective skills and knowledge.

SHAREHOLDERS' RIGHTS

To safeguard shareholders' interests and rights, a separate resolution is proposed for each substantially separate issue at general meetings, including the election of individual Directors. Except where the Chairman, in good faith, decides to allow a resolution which relates purely to a procedural or administrative matter to be voted on by a show of hands, all resolutions put forward at general meetings will be voted on by poll pursuant to the Listing Rules. Poll results will be posted on the websites of the Company and of the Hong Kong Stock Exchange after each general meeting. There are no provisions under the laws of the Cayman Islands or the Articles of Association that allows shareholders to make proposals or move resolutions at an annual general meeting. Shareholders of the Company who wish to make proposals or move a resolution may, however, request the Board to convene an extraordinary general meeting by following the procedures below.

PROCEDURES FOR SHAREHOLDERS TO CONVENE AN EXTRAORDINARY GENERAL MEETING

Extraordinary general meetings may be convened on the written request of any two or more shareholders of the Company deposited at the principal place of business of the Company in Hong Kong or, in the event the Company ceases to have such a principal place of business, the registered office specifying the objects of the meeting and signed by the requestors, provided that such requestors held as at the date of deposit of the request not less than one-tenth of the paid up capital of the Company which carries the right of voting at general meetings of the Company.

Extraordinary general meetings may also be convened on the written request of any one shareholder of the Company which is a recognised clearing house (or its nominee(s)) deposited at the principal place of business of the Company in Hong Kong or, in the event the Company ceases to have such a principal place of business, the registered office specifying the objects of the meeting and signed by the requestor, provided that such requestor held as at the date of deposit of the requisition not less than one-tenth of the paid up capital of the Company which carries the right of voting at general meetings of the Company.

Corporate Governance Report

If the Board does not within 21 days from the date of deposit of the request proceed duly to convene the extraordinary general meeting to be held within a further 21 days, the requestor(s) themselves, or any of them representing more than one-half of the total voting rights of all of them, may convene the extraordinary general meeting in the same manner, as nearly as possible, as that in which meetings may be convened by the Board provided that any meeting so convened shall not be held after the expiration of three months from the date of deposit of the request, and all reasonable expenses incurred by the requestor(s) as a result of the failure of the Board shall be reimbursed to them by the Company.

SHAREHOLDERS' ENQUIRIES

Enquiries about corporate governance or other related matters (including enquiries to be put to the Board) should be directed to the Company Secretary by email at company.secretary@nexteer.com or at the Company's headquarters address: 1272 Doris Road, Auburn Hills, Michigan 48326, USA.

Shareholders should direct their enquiries about their shareholdings to the Company's share registrar as follows:

By Mail: 17M Floor, Hopewell Centre
183 Queen's Road East
Wanchai, Hong Kong

Hong Kong Customer Service Phone: +852 2862 8555

Email: hkinfo@computershare.com.hk

REMUNERATION OF DIRECTORS AND SENIOR MANAGEMENT

The Group has established a formal and transparent procedure for formulating policies on remuneration of Directors and Senior Management of the Group. Details of the remuneration of each of the Directors for the year ended December 31, 2021 are set out in note 24 to the Consolidated Financial Statements. The remuneration of Directors is determined by the Board, which receives recommendations from the Remuneration and Nomination Committee after considering the experience, knowledge and performance of the Directors. Under the Company's current compensation arrangements, the Executive Directors and Senior Management receive cash compensation in the form of salaries as well as bonuses that are subject to performance targets.

Remuneration paid to the Senior Management (including three Executive Directors) for the year ended December 31, 2021 is within the following bands:

Band of remuneration in US\$	No. of person
US\$250,001 – US\$500,000	1
US\$500,001 – US\$750,000	6
US\$750,001 – US\$1,000,000	6
US\$1,000,001 – US\$1,250,000	2
US\$1,250,001 – US\$1,500,000	1
US\$1,500,001 – US\$1,750,000	1
US\$2,000,001 – US\$2,250,000	1
US\$6,250,001 – US\$6,500,000	1

Corporate Governance Report

DIRECTORS' RESPONSIBILITY FOR THE FINANCIAL STATEMENTS

The Company has implemented a series of reports intended to allow the Board to assess the Group's financial and operational performance, as well as business results. On a monthly basis, management of the Group provides the Board with sufficient and adequate information to support its decision-making and oversight responsibilities.

The Board understands and acknowledges its responsibility for overseeing the preparation of the financial information in accordance with IFRS and for the internal control system necessary to enable the preparation of financial information that is free from material misstatement. This responsibility extends to annual and interim reports, other announcements and other financial disclosures required under the Listing Rules and/or statutory requirements. As at the date of this annual report, the Board is not aware of any material uncertainties relating to events or conditions that may cast significant doubt upon the Company's or the Group's ability to continue as a going concern.

The Company's external auditor is responsible for expressing an opinion on whether the Consolidated Financial Statements give a true and fair view of the state of affairs of the Group as at December 31, 2021, and of the Group's profit and cash flows for the year then ended in accordance with IFRS.

The auditor's statement about their reporting responsibilities on the Consolidated Financial Statements is set out in the section headed 'Independent Auditor's Report' of this annual report.

RISK MANAGEMENT AND INTERNAL CONTROL

The Company has adopted a risk management and internal control system and associated procedures and conducts reviews of the effectiveness of the risk management and internal control system of the Group from time to time.

The responsibility for safeguarding the assets, for the prevention and detection of fraud and error, and for ensuring compliance with all applicable laws and regulations rests with the Board, the Audit and Compliance Committee and management of the Group. This responsibility includes implementing and ensuring the continued operation of the Group's risk management and internal control system which is designed to prevent and detect fraud and error.

The Board is responsible for maintaining an adequate system of risk management and internal control and for reviewing its effectiveness. Oversight over risk management and internal control is led by the Audit and Compliance Committee. While Senior Management is responsible for the implementation of such system of risk management and internal control, the Group has established an Internal Audit department to assist the Board and the Audit and Compliance Committee in their oversight and review responsibilities to monitor the compliance and effectiveness of the risk management and internal control measures. This will enable the Board and the Audit and Compliance Committee to conduct necessary reviews and to report to shareholders, at least on an annual basis, on the effectiveness of the Group's system of risk management and internal control. The risk management and internal control system is designed to manage rather than eliminate the risk of failure to achieve business objectives, and only provide reasonable and not absolute assurance against material misstatement or loss.

The head of the Internal Audit department has direct access to the Board through direct communication to the Chairman of the Audit and Compliance Committee. The head of the Internal Audit department has the right to consult the Audit and Compliance Committee without reference to management. With this independence, the Internal Audit department is able to perform key tasks, such as: (a) assessing and monitoring compliance with policies and the effectiveness of risk management and internal control measures with unrestricted direct access to any level of management whenever deemed necessary; and (b) conducting comprehensive internal audits to evaluate the system of financial, operation and compliance controls on a regular basis.

Corporate Governance Report

The Internal Audit department has completed a risk assessment process and developed an Internal Audit plan that focuses on the key risks to the Company. The Company reviewed the risk assessment and Internal Audit plans with the Audit and Compliance Committee in 2021. The Internal Audit department executed the Internal Audit plan and conducted a review of the effectiveness of the system of risk management and internal control for key high risk frameworks. The Internal Audit department reported a summary of audit findings and recommendations to the Audit and Compliance Committee. Management is responsible for ensuring that identified control weaknesses are rectified within a reasonable period.

Management and the CFO, in conjunction with the Board and the Audit and Compliance Committee, continue to evaluate the adequacy of resources, qualifications and experience of staff in the Group's accounting and financial reporting and Internal Audit functions, as well as that function's training programmes and budget. This exercise continues to result in the hiring of accounting and finance professionals to help ensure that the Group maintains adequate and sufficient staffing levels required for a public company. The Board has delegated to the Audit and Compliance Committee the responsibility for reviewing the Group's system of risk management and internal control and reporting the findings to the Board. The Audit and Compliance Committee conducted a review of (1) the findings and recommendations of the Internal Audit function; (2) the implementation status of recommended internal control recommendations; and (3) the reports and findings from management on the implementation of the internal control measures. Based on its annual review, the Board and the Audit and Compliance Committee are not aware of any material deficiencies in the effectiveness of risk management and internal control for the year ended December 31, 2021 and consider them effective and adequate.

Management identifies, evaluates and manages significant risks to the Group. Management annually self-assesses the effectiveness of the risk management and internal control activities. The Group's risk management and internal control policies and procedures are designed and updated (as necessary) in consideration of jurisdictional regulations, customer requirements and industry practice. The Group has successfully redesigned and continues to operate under its Business System meeting the International Automotive Task Force (IATF) and customer requirements, as well as promoting and focusing on continual improvements to its business processes and practices.

The risk management process facilitates the following sequence of activities and communication:



Risk management is a continuous process, occurring within functional departments, geographic segments and corporate oversight bodies. Management regularly assesses the nature, extent and magnitude of the identified risks and corresponding risk response plans. Management periodically evaluates the comparative significance of risk occurrence and consequences when considering risk response plans and associated plan effectiveness.

CHANGE IN CONSTITUTIONAL DOCUMENTS

There was no change in the Articles of Association of the Company for the year ended December 31, 2021.

Independent Auditor's Report

Deloitte.

德勤

INDEPENDENT AUDITOR'S REPORT TO THE SHAREHOLDERS OF NEXTEER AUTOMOTIVE GROUP LIMITED *(incorporated in the Cayman Islands with limited liability)*

OPINION

We have audited the consolidated financial statements of Nexteer Automotive Group Limited (the "**Company**") and its subsidiaries (collectively referred to as the "**Group**") set out on pages 96 to 169, which comprise the consolidated balance sheet as at December 31, 2021, and the consolidated income statement, consolidated statement of comprehensive income, consolidated statement of changes in equity and consolidated statement of cash flows for the year then ended, and notes to the consolidated financial statements, including a summary of significant accounting policies.

In our opinion, the consolidated financial statements give a true and fair view of the consolidated financial position of the Group as at December 31, 2021, and of its consolidated financial performance and its consolidated cash flows for the year then ended in accordance with International Financial Reporting Standards ("**IFRSs**") issued by the International Accounting Standards Board ("**IASB**") and have been properly prepared in compliance with the disclosure requirements of the Hong Kong Companies Ordinance.

BASIS FOR OPINION

We conducted our audit in accordance with International Standards on Auditing ("**ISAs**") issued by the International Auditing and Assurance Standards Board ("**IAASB**"). Our responsibilities under those standards are further described in the Auditor's Responsibilities for the Audit of the Consolidated Financial Statements section of our report. We are independent of the Group in accordance with the International Ethics Standards Board for Accountants' International Code of Ethics for Professional Accountants (including International Independence Standards) (the "**Code**"), and we have fulfilled our other ethical responsibilities in accordance with the Code. We believe that the audit evidence we have obtained is sufficient and appropriate to provide a basis for our opinion.

KEY AUDIT MATTERS

Key audit matters are those matters that, in our professional judgment, were of most significance in our audit of the consolidated financial statements of the current period. These matters were addressed in the context of our audit of the consolidated financial statements as a whole, and in forming our opinion thereon, and we do not provide a separate opinion on these matters.

Independent Auditor's Report

Key Audit Matters**How our audit addressed the key audit matter****Capitalisation of product development costs**

Refer to notes 2.7(a), 4.1(a)(i) and 8 to the consolidated financial statements.

The Group incurs significant costs and efforts on research and development activities, which include costs to develop customer-specific applications, prototypes and testing. As disclosed in note 8 to the consolidated financial statements, capitalised product development costs within intangible assets as at December 31, 2021 amounted to US\$707.8 million and product development costs capitalised during the year ended December 31, 2021 amounted to US\$156.4 million.

Our audit was focused on this area given the significance of the development costs capitalised during the year ended December 31, 2021, as well as the complexity of the process used by management to account for these costs. Management uses significant judgement as part of this process including assessing whether costs are appropriately identified for capitalisation and that such costs are appropriately associated with programmes in the development phase of production in accordance with the capitalisation criteria as set out in note 2.7(a) to the consolidated financial statements. The key inputs utilised by management to calculate the development costs to be capitalised include labour hours and labour rates applied, as well as material costs.

We obtained an analysis prepared by management of all individual development projects costs capitalised in the period and agreed this analysis to the amounts recorded in the general ledger. We considered the product development cost components included in the analysis for capitalisation and assessed the determination for capitalisation of such costs by comparing the nature of the costs capitalised by management to the capitalisation criteria as set out in note 2.7(a) to the consolidated financial statements.

We also tested samples of projects as follows:

- We met with finance management, inquired of engineers, and reviewed programme documentation to determine whether the programmes had entered the development phase of the projects and whether the associated costs were thus eligible for capitalisation. We conducted interviews with individual project managers responsible for the projects selected to corroborate management's explanations and to obtain an understanding of the development phase of the specific projects. We also inspected agreements between the Group and their customers to support existence of the development programmes. These procedures enabled us to assess whether the projects would allow the underlying expenditure to meet the criteria for capitalisation as set out in note 2.7(a) to the consolidated financial statements.
- To determine whether costs were directly attributable to projects, we obtained detailed listings of hours worked on individual projects and selected samples of the employees' hours recorded. We obtained timesheets approved by the appropriate project managers to check that the employees selected for testing were involved on the projects and to evaluate the nature of the work they had been performing. We also recalculated the amount of costs capitalised for the projects selected, by applying a labour rate per employee to the timesheet hours.
- We also compared the labour rates, referred to above, that had been applied to the hours identified as appropriate for capitalisation to the employee costs within the general ledger.
- To test whether material costs were directly attributable to projects and capitalisable, we tested samples of capitalised material costs to assess whether the programmes to which they were being applied were in the development phase.

Independent Auditor's Report

Key Audit Matters**How our audit addressed the key audit matter****Provision for warranties**

Refer to notes 4(b) and 18 to the consolidated financial statements.

The Group recognises expected warranty costs for products sold principally at the time of sale of the product or when it is determined that such obligations are probable and can be reliably estimated. As disclosed in note 18 to the consolidated financial statements, the warranties provision as at December 31, 2021 amounted to US\$55.8 million. Management estimates the amount that will eventually be required to settle such obligations and those estimates are based on a variety of factors.

We focused on this area given the significance of the provision and the longer period of time between when the initial estimates are recorded and warranty obligations are settled. These estimates require ongoing monitoring to determine the continued appropriateness of the recorded provision. The key estimates used by management in determining the warranty provision include the estimated repair cost per unit and the estimated number of defective products. Key inputs used in deriving this estimate include the customer's product repair cost per unit, the estimated percentage of defective products and the cost sharing arrangement between the Group and the customers.

We obtained an analysis prepared by management of the individual warranty provisions at the beginning and ending of the year and the movement in such provisions. We then agreed this analysis to the amounts recorded in the general ledger and tested significant reconciling items to supporting documentation.

We tested samples by performing the following:

- We obtained an understanding of the management's internal control and assessment process of provision for warranty and assessed the inherent risk of material misstatement by considering the degree of estimation uncertainty and level of other inherent risk factors such as complexity, subjectivity, changes and susceptibility to management bias or fraud.
- We recalculated the mathematical accuracy of the provision calculation (product volume multiplied by the estimated repair cost per unit).
- We traced the volume data to the related sales records for each product selected for testing, also determining whether the provision for the selected product was recorded in the appropriate period.
- We agreed the estimated customer's product repair cost per unit, the estimated percentage of defective products and the cost sharing arrangement to third party customer data and supply arrangements to evaluate whether the estimated repair cost per unit appropriately reflected the Group's obligations with respect to the repair or replacement of such products.
- We inspected the customer approved settlement agreements for warranty provision settled during the year, and checked the related payments made during the year, as applicable, to the relevant credit memo or cash payment to evaluate the reasonableness of the Group's historical estimates of repair cost per unit.

Independent Auditor's Report

OTHER MATTER

The consolidated financial statements of the Group for the year ended December 31, 2020 were audited by another auditor who expressed an unmodified opinion on those statements on March 17, 2021.

OTHER INFORMATION

The directors of the Company are responsible for the other information. The other information comprises the information included in the annual report, but does not include the consolidated financial statements and our auditors report thereon.

Our opinion on the consolidated financial statements does not cover the other information and we do not express any form of assurance conclusion thereon.

In connection with our audit of the consolidated financial statements, our responsibility is to read the other information and, in doing so, consider whether the other information is materially inconsistent with the consolidated financial statements or our knowledge obtained in the audit or otherwise appears to be materially misstated. If, based on the work we have performed, we conclude that there is a material misstatement of this other information, we are required to report that fact. We have nothing to report in this regard.

RESPONSIBILITIES OF DIRECTORS AND THOSE CHARGED WITH GOVERNANCE FOR THE CONSOLIDATED FINANCIAL STATEMENTS

The directors of the Company are responsible for the preparation of the consolidated financial statements that give a true and fair view in accordance with IFRSs issued by the IASB and the disclosure requirements of the Hong Kong Companies Ordinance, and for such internal control as the directors determine is necessary to enable the preparation of consolidated financial statements that are free from material misstatement, whether due to fraud or error.

In preparing the consolidated financial statements, the directors are responsible for assessing the Group's ability to continue as a going concern, disclosing, as applicable, matters related to going concern and using the going concern basis of accounting unless the directors either intend to liquidate the Group or to cease operations, or have no realistic alternative but to do so.

Those charged with governance are responsible for overseeing the Group's financial reporting process.

Independent Auditor's Report

AUDITOR'S RESPONSIBILITIES FOR THE AUDIT OF THE CONSOLIDATED FINANCIAL STATEMENTS

Our objectives are to obtain reasonable assurance about whether the consolidated financial statements as a whole are free from material misstatement, whether due to fraud or error, and to issue an auditor's report that includes our opinion solely to you, as a body, in accordance with our agreed terms of engagement, and for no other purpose. We do not assume responsibility towards or accept liability to any other person for the contents of this report. Reasonable assurance is a high level of assurance, but is not a guarantee that an audit conducted in accordance with ISAs will always detect a material misstatement when it exists. Misstatements can arise from fraud or error and are considered material if, individually or in the aggregate, they could reasonably be expected to influence the economic decisions of users taken on the basis of these consolidated financial statements.

As part of an audit in accordance with ISAs, we exercise professional judgment and maintain professional skepticism throughout the audit. We also:

- Identify and assess the risks of material misstatement of the consolidated financial statements, whether due to fraud or error, design and perform audit procedures responsive to those risks, and obtain audit evidence that is sufficient and appropriate to provide a basis for our opinion. The risk of not detecting a material misstatement resulting from fraud is higher than for one resulting from error, as fraud may involve collusion, forgery, intentional omissions, misrepresentations, or the override of internal control.
- Obtain an understanding of internal control relevant to the audit in order to design audit procedures that are appropriate in the circumstances, but not for the purpose of expressing an opinion on the effectiveness of the Group's internal control.
- Evaluate the appropriateness of accounting policies used and the reasonableness of accounting estimates and related disclosures made by the directors.
- Conclude on the appropriateness of the directors' use of the going concern basis of accounting and, based on the audit evidence obtained, whether a material uncertainty exists related to events or conditions that may cast significant doubt on the Group's ability to continue as a going concern. If we conclude that a material uncertainty exists, we are required to draw attention in our auditor's report to the related disclosures in the consolidated financial statements or, if such disclosures are inadequate, to modify our opinion. Our conclusions are based on the audit evidence obtained up to the date of our auditor's report. However, future events or conditions may cause the Group to cease to continue as a going concern.
- Evaluate the overall presentation, structure and content of the consolidated financial statements, including the disclosures, and whether the consolidated financial statements represent the underlying transactions and events in a manner that achieves fair presentation.
- Obtain sufficient appropriate audit evidence regarding the financial information of the entities or business activities within the Group to express an opinion on the consolidated financial statements. We are responsible for the direction, supervision and performance of the group audit. We remain solely responsible for our audit opinion.

We communicate with those charged with governance regarding, among other matters, the planned scope and timing of the audit and significant audit findings, including any significant deficiencies in internal control that we identify during our audit.

We also provide those charged with governance with a statement that we have complied with relevant ethical requirements regarding independence, and to communicate with them all relationships and other matters that may reasonably be thought to bear on our independence, and where applicable, actions taken to eliminate threats or safeguards applied.

Independent Auditor's Report

From the matters communicated with those charged with governance, we determine those matters that were of most significance in the audit of the consolidated financial statements of the current period and are therefore the key audit matters. We describe these matters in our auditor's report unless law or regulation precludes public disclosure about the matter or when, in extremely rare circumstances, we determine that a matter should not be communicated in our report because the adverse consequences of doing so would reasonably be expected to outweigh the public interest benefits of such communication.

The engagement partner on the audit resulting in the independent auditor's report is Hung Suk Fan.

Deloitte Touche Tohmatsu
Certified Public Accountants

Hong Kong
March 16, 2022

Consolidated Balance Sheet

As at December 31, 2021

		As at December 31,	
	Notes	2021 US\$'000	2020 US\$'000
ASSETS			
Non-current assets			
Property, plant and equipment	6	988,896	1,009,333
Right-of-use assets	7	63,389	57,339
Intangible assets	8	708,807	657,493
Deferred income tax assets	9	11,361	11,805
Investments in joint ventures	31b	22,904	22,282
Other receivables and prepayments	12	50,917	51,482
		1,846,274	1,809,734
Current assets			
Inventories	10	288,632	234,047
Trade receivables	11	626,078	593,027
Other receivables and prepayments	12	118,990	115,497
Restricted bank deposits	13	9	12
Cash and cash equivalents	14	326,516	553,424
		1,360,225	1,496,007
Total assets		3,206,499	3,305,741

The notes on pages 102 to 169 are an integral part of these Consolidated Financial Statements.

Consolidated Balance Sheet

	Notes	As at December 31,	
		2021 US\$'000	2020 US\$'000
EQUITY			
Capital and reserves attributable to equity holders of the Company			
Share capital	33	32,377	32,347
Other reserves	15	33,893	58,652
Retained earnings		1,888,359	1,791,003
		1,954,629	1,882,002
Non-controlling interests		47,960	38,983
Total equity		2,002,589	1,920,985
LIABILITIES			
Non-current liabilities			
Lease liabilities	7	49,972	43,827
Retirement benefits and compensations	17	22,695	25,061
Deferred income tax liabilities	9	26,741	62,848
Provisions	18	60,608	59,429
Deferred revenue	19	86,737	69,071
Other payables and accruals	21	15,030	16,982
		261,783	277,218
Current liabilities			
Trade payables	20	666,501	657,155
Other payables and accruals	21	120,408	132,105
Current income tax liabilities		13,733	12,392
Retirement benefits and compensations	17	3,613	3,381
Provisions	18	17,388	18,697
Deferred revenue	19	23,691	21,645
Lease liabilities	7	12,390	13,527
Borrowings	16	84,403	248,636
		942,127	1,107,538
Total liabilities		1,203,910	1,384,756
Total equity and liabilities		3,206,499	3,305,741

The notes on pages 102 to 169 are an integral part of these Consolidated Financial Statements.

The Consolidated Financial Statements on pages 96 to 169 were approved by the Board of Directors on March 16, 2022 and were signed on its behalf.

ZHAO, Guibin

Director

FAN, Yi

Director

Consolidated Income Statement

For the year ended December 31, 2021

	Notes	For the year ended December 31,	
		2021 US\$'000	2020 US\$'000
Revenue	5	3,358,725	3,032,210
Cost of sales	23	(2,995,296)	(2,620,834)
Gross profit		363,429	411,376
Engineering and product development costs	23	(116,299)	(153,576)
Selling and distribution expenses	23	(17,662)	(16,934)
Administrative expenses	23	(131,391)	(112,603)
Other gains (losses), net	22	17,138	(9,536)
Operating profit		115,215	118,727
Finance income	25	4,426	4,096
Finance costs	25	(6,281)	(9,156)
	25	(1,855)	(5,060)
Share of results of joint ventures	31b	653	795
Profit before income tax		114,013	114,462
Income tax benefit	26	12,390	7,841
Profit for the year		126,403	122,303
Profit attributable to:			
Equity holders of the Company		118,440	116,766
Non-controlling interests		7,963	5,537
		126,403	122,303
Earnings per share for profit attributable to equity holders of the Company for the year (expressed in US\$ per share)			
– Basic and diluted	27	US\$0.05	US\$0.05

The notes on pages 102 to 169 are an integral part of these Consolidated Financial Statements.

Consolidated Statement of Comprehensive Income

For the year ended December 31, 2021

	For the year ended December 31,	
	2021 US\$'000	2020 US\$'000
Profit for the year	126,403	122,303
Other comprehensive (loss) income		
<i>Item that will not be reclassified to profit or loss</i>		
Actuarial gains (losses) on defined benefit plans, net of tax of US\$452,000 (2020: (US\$540,000))	1,452	(1,718)
<i>Item that may be reclassified subsequently to profit or loss</i>		
Exchange differences	(24,525)	38,698
	(23,073)	36,980
Total comprehensive income for the year	103,330	159,283
Total comprehensive income for the year attributable to:		
Equity holders of the Company	94,353	151,509
Non-controlling interests	8,977	7,774
	103,330	159,283

The notes on pages 102 to 169 are an integral part of these Consolidated Financial Statements.

Consolidated Statement of Changes in Equity

For the year ended December 31, 2021

	Attributable to equity holders of the Company							Non-controlling interests US\$'000	Total US\$'000
	Share capital US\$'000	Share premium US\$'000 (note 15)	Merger reserve US\$'000 (note 15)	Share-based compensation reserve US\$'000 (note 15)	Exchange reserve US\$'000 (note 15)	Retained earnings US\$'000	Sub-total US\$'000		
As at January 1, 2020	32,347	-	113,000	6,916	(97,732)	1,757,450	1,811,981	39,675	1,851,656
Comprehensive income									
Profit for the year	-	-	-	-	-	116,766	116,766	5,537	122,303
Other comprehensive income (loss)									
Exchange differences	-	-	-	-	36,461	-	36,461	2,237	38,698
Actuarial losses on defined benefit plans, net of tax	-	-	-	-	-	(1,718)	(1,718)	-	(1,718)
Total other comprehensive income (loss)	-	-	-	-	36,461	(1,718)	34,743	2,237	36,980
Total comprehensive income	-	-	-	-	36,461	115,048	151,509	7,774	159,283
Transactions with owners									
Value of employee services provided under Share Option Scheme (note 24(a))	-	-	-	7	-	-	7	-	7
Dividends paid to shareholders	-	-	-	-	-	(81,495)	(81,495)	-	(81,495)
Dividends paid to non-controlling interests	-	-	-	-	-	-	-	(8,466)	(8,466)
Total transactions with owners	-	-	-	7	-	(81,495)	(81,488)	(8,466)	(89,954)
As at December 31, 2020	32,347	-	113,000	6,923	(61,271)	1,791,003	1,882,002	38,983	1,920,985
Comprehensive income									
Profit for the year	-	-	-	-	-	118,440	118,440	7,963	126,403
Other comprehensive (loss) income									
Exchange differences	-	-	-	-	(25,539)	-	(25,539)	1,014	(24,525)
Actuarial gains on defined benefit plans, net of tax	-	-	-	-	-	1,452	1,452	-	1,452
Total other comprehensive (loss) income	-	-	-	-	(25,539)	1,452	(24,087)	1,014	(23,073)
Total comprehensive (loss) income	-	-	-	-	(25,539)	119,892	94,353	8,977	103,330
Transactions with owners									
Value of employee services provided under Share Option Scheme (note 24(a))	-	-	-	21	-	-	21	-	21
Transfer to share premium under exercise of share options	-	883	-	(883)	-	-	-	-	-
Proceeds from exercise of share options	30	1,804	-	-	-	-	1,834	-	1,834
Dividends paid to shareholders	-	(1,045)	-	-	-	(22,536)	(23,581)	-	(23,581)
Total transactions with owners	30	1,642	-	(862)	-	(22,536)	(21,726)	-	(21,726)
As at December 31, 2021	32,377	1,642	113,000	6,061	(86,810)	1,888,359	1,954,629	47,960	2,002,589

The notes on pages 102 to 169 are an integral part of these Consolidated Financial Statements.

Consolidated Statement of Cash Flows

For the year ended December 31, 2021

	Note	For the year ended December 31,	
		2021 US\$'000	2020 US\$'000
Operating activities			
Cash generated from operations	29(a)	318,897	448,519
Income tax paid, net		(31,514)	(28,674)
Net cash generated from operating activities		287,383	419,845
Investing activities			
Purchase of property, plant and equipment		(141,601)	(149,741)
Addition of intangible assets		(146,679)	(137,734)
Other		2,616	(527)
Net cash used in investing activities		(285,664)	(288,002)
Financing activities			
Proceeds from borrowings	29(b)	144,144	106,086
Repayments of borrowings	29(b)	(308,642)	(166,248)
Repayments of lease liabilities	29(b)	(13,709)	(13,672)
Finance costs paid		(15,494)	(23,148)
Dividends paid to equity holders of the Company		(23,581)	(81,495)
Dividends paid to non-controlling interests		–	(8,466)
Proceeds from exercise of share options		1,834	–
Net cash used in financing activities		(215,448)	(186,943)
Net decrease in cash and cash equivalents		(213,729)	(55,100)
Cash and cash equivalents at beginning of year		553,424	601,827
Effect of exchange rate changes on cash and cash equivalents		(13,179)	6,697
Cash and cash equivalents at end of year		326,516	553,424

The notes on pages 102 to 169 are an integral part of these Consolidated Financial Statements.

Notes to the Consolidated Financial Statements

For the year ended December 31, 2021

1 GENERAL INFORMATION

Nexteer Automotive Group Limited (the **Company**) was incorporated in the Cayman Islands on August 21, 2012 as an exempted company with limited liability under Companies Law (as amended), of the Cayman Islands. The address of the Company's registered office is P.O. Box 309, Ugland House, Grand Cayman, KY1-1104, Cayman Islands.

The Company is an investment holding company. The Company, together with its subsidiaries (collectively referred to as the **Group**), are principally engaged in the design and manufacture of steering and driveline systems, Advanced Driver Assistance Systems (**ADAS**) and Automated Driving (**AD**) and components for automobile manufacturers and other automotive-related companies. The Group's primary operations are in the United States of America (**USA** or **US**), Mexico, Poland and the People's Republic of China (**China**) and are structured to supply its customers globally. The principal markets for the Group's products are North America, Europe, South America, China and India.

The Company's directors regard Aviation Industry Corporation of China, Ltd. (**AVIC**), a company established in China, as being the ultimate holding company of the Company. The Company's immediate holding company is Nexteer Automotive (Hong Kong) Holdings Limited.

The Company's shares have been listed on the Main Board of The Stock Exchange of Hong Kong Limited since October 7, 2013 (the **Listing**).

These consolidated financial statements (the **Consolidated Financial Statements**) are presented in thousands of US dollars (**US\$'000**), unless otherwise stated. The Consolidated Financial Statements were approved by the Board of Directors of the Company (the **Board**) for issue on March 16, 2022.

2 SUMMARY OF SIGNIFICANT ACCOUNTING POLICIES

The principal accounting policies applied in the preparation of these Consolidated Financial Statements are set out below. These policies have been consistently applied to all the years presented, unless otherwise stated.

2.1 Basis of preparation

The Consolidated Financial Statements have been prepared in accordance with International Financial Reporting Standards (**IFRS**) as issued by the International Accounting Standards Board. In addition, the Consolidated Financial Statements include applicable disclosures required by the Rules Governing the Listing of Securities on The Stock Exchange of Hong Kong Limited and by the Hong Kong Companies Ordinance. The Consolidated Financial Statements have been prepared under the historical cost convention except for notes receivable that are measured at fair value.

The preparation of financial statements in conformity with IFRS requires the use of certain critical accounting estimates. It also requires management to exercise its judgement in the process of applying the Group's accounting policies. The areas involving a higher degree of judgement or complexity, or areas where assumptions and estimates are significant to the Consolidated Financial Statements are disclosed in note 4.

Notes to the Consolidated Financial Statements

2 SUMMARY OF SIGNIFICANT ACCOUNTING POLICIES (Continued)

2.1 Basis of preparation (Continued)

COVID-19 Update

Throughout 2020, the COVID-19 pandemic materially impacted the Group's business and results of operations. During the first quarter of 2020, the impact of COVID-19 was initially experienced primarily by operations in China. Following the declaration of COVID-19 as a global pandemic on March 11, 2020, government authorities around the world began to impose shelter-in-place orders and other restrictions. As a result, many original equipment manufacturers (**OEMs**) began suspending manufacturing operations, particularly in North America and Europe. This led to various temporary closures of, or reduced operations at, the Group's manufacturing facilities, late in the first quarter of 2020 and throughout the second quarter of 2020. During the second half of 2020, as the global management of COVID-19 evolved and government restrictions were removed or lessened, production levels improved, and substantially all of the Group's production facilities resumed closer to normal operations by the third quarter of 2020.

The global automotive industry continued to be impacted by the COVID-19 pandemic throughout 2021, particularly a result of supply shortages as OEM production demand continued to recover. The most significant supply shortage related to semiconductor chips, which impacted global industry production, and resulted in significant cancellations of planned OEM production. Supply shortages and the ongoing volatility in OEM production schedules adversely impacted our manufacturing and material efficiencies during 2021. In addition, increases in certain commodity and logistics costs had an adverse impact on our operating results for the year ended December 31, 2021. It is possible a resurgence of the COVID-19 pandemic could result in adverse impacts in the future. Management cannot reasonably estimate the full impact the COVID-19 pandemic could have on the Group's financial condition, results of operations or cash flows in the future.

The Group assessed certain accounting matters that require consideration of forecasted financial information, including, but not limited to, its allowance for credit losses, the carrying value of the Group's intangible assets and other long-lived assets, and valuation allowances in context with the information reasonably available to the Group and the unknown future impacts of COVID-19 as at December 31, 2021 and through the date of this report. As a result of these assessments, there were no material increases in credit allowances or valuation allowances that impacted the Group's Consolidated Financial Statements as at and for the year ended December 31, 2021. However, the Group's future assessment of the magnitude and duration of COVID-19, as well as other factors, could result in material impacts to the Consolidated Financial Statements in future reporting periods. The Group recorded impairments to programme development intangible assets for the year ended December 31, 2021, as set out in note 8.

Given the ever-changing and uncertain worldwide situation regarding COVID-19 and its potential further impacts on the economies of afflicted regions, and the inherent difficulty in predicting potential further impact on the Group's facilities, employees, customers, suppliers and logistics providers, the Group has made assumptions based on best available information but due to the uncertainties related to COVID-19 the actual results may be materially different than the current assumptions used by management.

2.2 Subsidiaries

(a) *Consolidation*

Subsidiaries are all entities over which the Group has control. The Group controls an entity where the Group is exposed to, or has rights to, variable returns from its involvement with the entity and has the ability to affect those returns through its power to direct the activities of the entity. Subsidiaries are fully consolidated from the date on which control is transferred to the Group and are deconsolidated from the date that control ceases. Upon consolidation, intercompany transactions, balances, income and expenses on transactions between group companies are eliminated. Profits and losses resulting from intercompany transactions that are recognised in assets are also eliminated.

Notes to the Consolidated Financial Statements

2 SUMMARY OF SIGNIFICANT ACCOUNTING POLICIES (Continued)**2.2 Subsidiaries** (Continued)*(b) Separate financial statements*

Investments in subsidiaries are accounted for at cost less impairment. Cost also includes direct attributable costs of investment. The results of subsidiaries are accounted for by the Company on the basis of dividends received and receivable.

Impairment testing of the investments in subsidiaries is required when there is indication that the investments may be impaired. Impairment indicators may include receiving dividends in an amount that exceeds the total comprehensive income of the subsidiary in the period the dividend is declared or if the carrying amount of the investment in the separate financial statements exceeds the carrying amount in the Consolidated Financial Statements of the subsidiary's net assets including goodwill.

2.3 Joint arrangements

Joint arrangements are classified as either joint operations or joint ventures, depending on the contractual rights and obligations of each investor. The Group has assessed the nature of its joint arrangements and accounts for these as joint ventures using the equity method of accounting.

Under the equity method of accounting, interests in joint ventures are initially recognised at cost and adjusted thereafter to recognise the Group's share of the post-acquisition profits or losses and movements in other comprehensive income. When the Group's share of losses in a joint venture equals or exceeds its interests in the joint ventures (which includes any long-term interests that, in substance, form part of the Group's net investment in the joint venture), the Group does not recognise further losses, unless it has incurred obligations or made payments on behalf of the joint ventures. Any distributions the Group receives from the joint ventures reduce the carrying amount of the investment.

Unrealised gains on transactions between the Group and its joint ventures are eliminated to the extent of the Group's interests in the joint ventures. Unrealised losses are also eliminated unless the transaction provides evidence of an impairment of the asset transferred. Accounting policies of the joint ventures have been aligned where necessary to ensure consistency with the policies adopted by the Group.

Notes to the Consolidated Financial Statements

2 SUMMARY OF SIGNIFICANT ACCOUNTING POLICIES (Continued)**2.4 Segment reporting**

Operating segments are reported in a manner consistent with the internal reporting to the chief operating decision maker who has been identified as the Chief Executive Officer (**CEO**). The CEO is responsible for resource allocation and assessing the performance of the operating segments.

2.5 Foreign currency translation*(a) Functional and presentation currency*

Items included in the financial statements of each of the Group's entities are measured using functional currency in accordance with IAS 21, 'The Effects of Changes in Foreign Exchange Rates'. The Consolidated Financial Statements are presented in US dollars, which is the Company's functional currency and the Group's presentation currency.

(b) Transactions and balances

Foreign currency transactions are translated into the functional currency using the exchange rates prevailing at the dates of the transactions or valuation where items are re-measured. Foreign exchange gains and losses resulting from the settlement of such transactions and from the translation at year-end exchange rates of monetary assets and liabilities denominated in foreign currencies are recognised in the consolidated income statement.

(c) Group companies

The results of operations and financial position of all the group entities (none of which has the currency of a hyper-inflationary economy) that have a functional currency different from the presentation currency are translated into the presentation currency as follows:

- (i) Assets and liabilities for each balance sheet presented are translated at the closing rate at the date of that balance sheet;
- (ii) Income and expenses for each income statement are translated at average exchange rates (unless this average is not a reasonable approximation of the cumulative effect of the rates prevailing on the transaction dates, in which case income and expenses are translated at the rate on the dates of the related transactions); and
- (iii) All resulting exchange differences are recognised in other comprehensive income and loss.

Notes to the Consolidated Financial Statements

2 SUMMARY OF SIGNIFICANT ACCOUNTING POLICIES (Continued)**2.6 Property, plant and equipment**

Items of property, plant and equipment (including tools but excluding construction-in-progress) are measured at cost less accumulated depreciation and accumulated impairment losses. Improvements that materially extend the useful life of these assets are capitalised. When parts of an item of property, plant and equipment have different useful lives, they are accounted for as separate items (major components) of property, plant and equipment.

Subsequent costs are included in the asset's carrying amount or as a separate asset, as appropriate, only when it is probable that future economic benefits associated with the item will flow to the Group and the cost of the item can be measured reliably. The carrying amount of the replaced part is derecognised. All other repairs and maintenance are charged to the consolidated income statement during the financial period in which they are incurred.

Freehold land is not depreciated. Depreciation on items of property, plant and equipment is calculated using the straight-line basis to allocate their cost to their residual values over their estimated useful lives as follows:

Land improvements	3-20 years
Leasehold improvements	6-18 years or over lease term, whichever is shorter
Buildings	20-40 years
Machinery, equipment and tooling	3-20 years
Furniture and office equipment	3-18 years

Tooling represents tools, dies, jigs and other items used in the manufacturing of customer-specific parts. Tools owned by the Group are capitalised as property, plant and equipment and depreciated to cost of sales over their useful lives.

The assets' residual values and useful lives are reviewed annually and adjusted if appropriate.

An asset's carrying amount is written down immediately to its recoverable amount if the asset's carrying amount is greater than its estimated recoverable amount (note 2.8).

Gains and losses on disposal are determined by comparing the proceeds with the carrying amount and are recognised within other gains (losses), net in the Consolidated Financial Statements.

Construction-in-progress represents leasehold improvements, buildings, machinery and equipment under construction or pending installation and is stated at cost less accumulated impairment losses. Cost includes the costs of construction, installation, testing and other direct costs, and capitalised interest. No provision for depreciation is made on construction-in-progress until such time as the relevant assets are completed and ready for intended use.

Notes to the Consolidated Financial Statements

2 SUMMARY OF SIGNIFICANT ACCOUNTING POLICIES (Continued)**2.7 Intangible assets***(a) Research and development*

The Group incurs significant costs and effort on research and development activities, which include expenditures on customer-specific applications, prototypes and testing. Research expenditures are charged to the consolidated income statement as an expense in the period the expenditure is incurred. Development costs are recognised as assets if they can be clearly assigned to a newly developed product or process and all the following can be demonstrated:

- (i) The technical feasibility to complete the development project so that it will be available for use or sale;
- (ii) The intention to complete the development project to use it;
- (iii) The ability to use the output of the development project;
- (iv) The manner in which the development project will generate probable future economic benefits for the Group;
- (v) The availability of adequate technical, financial and other resources to complete the development project and use or sell the intangible asset; and
- (vi) The expenditure attributable to the asset during its development can be reliably measured.

The cost of an internally generated intangible asset is the sum of the expenditure incurred from the date the asset meets the recognition criteria above to the date when it is available for use. The costs capitalised in connection with the intangible asset include costs of materials and services used or consumed and employee costs incurred in the creation of the asset. Development expenditures not satisfying the above criteria are recognised in the consolidated income statement as incurred.

Capitalised development costs are amortised using the straight-line method over the life of the related production programme, usually four to eight years.

(b) Computer software

Costs associated with maintaining computer software programmes are recognised as an expense as incurred. Development costs that are directly attributable to the design and testing of identifiable and unique software products controlled by the Group are recognised as intangible assets when the following criteria are met:

- (i) It is technically feasible to complete the software product and use it;
- (ii) Management intends to complete the software product and use it;
- (iii) There is an ability to use the software product;
- (iv) It can be demonstrated how the software product will generate probable future economic benefits;
- (v) Adequate technical, financial and other resources to complete the development and to use the software product are available; and

Notes to the Consolidated Financial Statements

2 SUMMARY OF SIGNIFICANT ACCOUNTING POLICIES (Continued)**2.7 Intangible assets** (Continued)*(b) Computer software* (Continued)

- (vi) The expenditure attributable to the software product during its development can be reliably measured.

Directly attributable costs that are capitalised as part of the software product include the software development employee costs and an appropriate portion of relevant overhead costs.

Development costs not satisfying the above criteria are recognised as an expense as incurred. Development costs previously recognised as an expense are not recognised as an asset in the subsequent period.

Computer software development costs recognised as assets are amortised using the straight-line method over their estimated useful lives, which does not exceed five years.

2.8 Impairment of non-financial assets

Intangible development assets not ready to use are not subject to amortisation and are tested annually for impairment and whenever there is an indication of impairment. Assets that are subject to depreciation/amortisation are reviewed for impairment whenever events or changes in circumstances indicate that the carrying amount may not be recoverable. An impairment loss is recognised for the amount by which the asset's carrying amount exceeds its recoverable amount. The recoverable amount is the higher of an asset's fair value less costs to sell and value in use. For the purposes of assessing impairment, assets are tested for impairment individually. When it is not possible to estimate the recoverable amount individually, assets are grouped at the lowest levels for which there are separately identifiable cash flows (**cash-generating units**). Non-financial assets that suffered an impairment are reviewed for possible reversal of the impairment at each reporting date.

In testing a cash-generating unit for impairment, corporate assets are allocated to the relevant cash-generating unit when a reasonable and consistent basis of allocation can be established, or otherwise they are allocated to the smallest group of cash-generating units for which a reasonable and consistent allocation basis can be established. The recoverable amount is determined for the cash-generating unit or group of cash-generating units to which the corporate asset belongs, and is compared with the carrying amount of the relevant cash-generating unit or group of cash-generating units.

2.9 Financial assets*(a) Classification*

The Group classified its financial assets in the following measurement categories:

- those to be measured subsequently at fair value (either through other comprehensive income or through profit or loss), and
- those to be measured at amortised cost.

The classification depends on the entity's business model for managing the financial assets and the contractual terms of the cash flows.

The Group's financial assets primarily comprise cash and cash equivalents, restricted bank deposits, trade receivables, notes receivable and other receivables.

Financial assets are included in current assets, except for the amounts that are expected to be realised beyond the Group's normal operating cycle, or that are expected to be settled more than 12 months after the end of the reporting period. These are classified as non-current assets.

Notes to the Consolidated Financial Statements

2 SUMMARY OF SIGNIFICANT ACCOUNTING POLICIES (Continued)**2.9 Financial assets (Continued)***(b) Recognition and measurement*

Regular way purchases and sales of financial assets are recognised on the trade-date – the date on which the Group commits to purchase or sell the asset. Financial assets are initially recognised at fair value plus transaction costs for all financial assets not carried at fair value through profit or loss (other than trade receivables arising from contracts with customers which are initially measured in accordance with IFRS 15 “Revenue from Contracts with Customers”). Financial assets carried at fair value through profit or loss are initially recognised at fair value, and transaction costs are expensed in the consolidated income statement. Financial assets are derecognised when the rights to receive cash flows from the investments have expired or have been transferred and the Group has transferred substantially all risks and rewards of ownership.

Subsequent measurement of financial assets depends on the Group’s business model for managing the asset and the cash flow characteristics of the asset. Assets that are held for collection of contractual cash flows where those cash flows represent solely payments of principal and interest are measured at amortised cost. Interest income from these financial assets is included in finance income using the effective interest rate method. Any gain or loss arising on derecognition is recognised directly in profit or loss and presented in other gains (losses), net together with foreign exchange gains and losses.

Financial assets that are held within a business model whose objective is achieved by both selling and collecting contractual cash flows and have contractual terms that give rise on specified dates to cash flows that are solely payments of principal and interest on the principal amount outstanding are subsequently measured at fair value through other comprehensive income (FVOCI). Subsequent changes in the carrying amounts of financial assets classified as FVOCI as a result of interest income calculated using the effective interest method and foreign exchange gains and losses are recognised in profit or loss. All other changes in the carrying amount of these financial assets are recognised in other comprehensive income. When these financial assets are derecognised, the cumulative gains or losses previously recognised in other comprehensive income are reclassified to profit or loss.

The Group’s notes receivable are measured at FVOCI and all other financial assets are measured at amortised cost.

(c) Impairment of financial assets

On a forward-looking basis, the Group assesses the expected credit losses associated with its financial assets carried at amortised cost and at FVOCI. The impairment methodology applied depends on whether there has been a significant increase in credit risk. For trade receivables, the Group applies the simplified approach required by IFRS 9 ‘Financial Instruments’ (**IFRS 9**), which requires lifetime expected credit losses to be recognised from initial recognition of these trade receivables. For other financial assets at amortised cost, the Group recognises a loss allowance equal to 12-month expected credit losses unless there has been a significant increase in credit risk of the financial assets since initial recognition, in which case the loss allowance is measured at an amount equal to lifetime expected credit losses. For notes receivable measured at FVOCI, impairment allowances are recognised in profit or loss with corresponding adjustment to other comprehensive income without reducing the carrying amounts of notes receivable.

In assessing whether the credit risk has increased significantly since initial recognition, the Group compares the risk of a default occurring on the financial instrument as at the reporting date with the risk of a default occurring on the financial instrument as at the date of initial recognition. In making this assessment, the Group considers both quantitative and qualitative information that is reasonable and supportable, including historical experience and forward-looking information that is available without undue cost or effort.

Notes to the Consolidated Financial Statements

2 SUMMARY OF SIGNIFICANT ACCOUNTING POLICIES (Continued)**2.9 Financial assets** (Continued)*(c) Impairment of financial assets* (Continued)

In particular, the following information is taken into account when assessing whether credit risk has increased significantly:

- an actual or expected significant deterioration in the financial instrument's external (if available) or internal credit rating;
- significant deterioration in external market indicators of credit risk, e.g. a significant increase in the credit spread, the credit default swap prices for the debtor;
- existing or forecast adverse changes in business, financial or economic conditions that are expected to cause a significant decrease in the debtor's ability to meet its debt obligations;
- an actual or expected significant deterioration in the operating results of the debtor;
- an actual or expected significant adverse change in the regulatory, economic or technological environment of the debtor that results in a significant decrease in the debtor's ability to meet its debt obligations.

Irrespective of the outcome of the above assessment, the Group presumes that the credit risk has increased significantly since initial recognition when contractual payments are more than 30 days past due, unless the Group has reasonable and supportable information that demonstrates otherwise.

The Group regularly monitors the effectiveness of the criteria used to identify whether there has been a significant increase in credit risk and revises them as appropriate to ensure that the criteria are capable of identifying significant increase in credit risk before the amount becomes past due.

For internal credit risk management, the Group considers an event of default occurs when information developed internally or obtained from external sources indicates that the debtor is unlikely to pay its creditors, including the Group, in full (without taking into account any collaterals held by the Group). Irrespective of the above, the Group considers that default has occurred when a financial asset is more than 90 days past due unless the Group has reasonable and supportable information to demonstrate that a more lagging default criterion is more appropriate.

The Group writes off a financial asset when there is no reasonable expectation of recovery. A write-off constitutes a derecognition event. Any subsequent recoveries are recognised in profit or loss.

Notes to the Consolidated Financial Statements

2 SUMMARY OF SIGNIFICANT ACCOUNTING POLICIES (Continued)**2.9 Financial assets (Continued)****(d) Derecognition of financial assets**

The Group derecognises a financial asset only when the contractual rights to the cash flows from the assets expire, or when it transfers the financial asset or substantially all the risks and rewards of ownership of the asset to another entity. On derecognition of a financial asset measured at amortised cost, the difference between the asset's carrying amount and the sum of the consideration received and receivable is recognised in profit or loss. On derecognition of notes receivable classified as FVOCI, the cumulative gain or loss previously accumulated in other comprehensive income is reclassified to profit or loss.

2.10 Inventories

Inventories are stated at the lower of cost and net realisable value. Cost is determined using the first-in, first-out method. Inventory cost includes direct material, direct labour and related manufacturing overhead costs (based on normal operating capacity). Net realisable value is the estimated selling price in the ordinary course of business, less all estimated costs of completion and costs necessary to make the sale. Costs necessary to make the sale include incremental costs directly attributable to the sale and non-incremental costs which the Group must incur to make the sale.

2.11 Trade receivables and other receivables and prepayments

Trade receivables are amounts due from customers for merchandise sold or services performed in the ordinary course of business. If collection of trade and other receivables is expected in one year or less (or in the normal operating cycle of the business if longer), they are classified as current assets. If not, they are presented as non-current assets.

2.12 Cash and cash equivalents

Cash and cash equivalents includes cash in hand, deposits held at call with banks and other short-term highly liquid investments with original maturities of three months or less.

2.13 Share capital

Ordinary shares are classified as equity. Incremental costs directly attributable to the issue of new shares are included in equity as a deduction from the proceeds.

2.14 Financial liabilities

Financial liabilities are recognised when the Group becomes a party to the contractual provisions of the instrument. Financial liabilities are initially measured at fair value. Transaction costs directly attributable to the issue of financial liabilities are deducted from the fair value of the financial liabilities on initial recognition.

The Group's financial liabilities are subsequently measured at amortised cost using the effective interest method.

The Group derecognises financial liabilities when, and only when, the Group's obligations are discharged, cancelled or have expired. The difference between the carrying amount of the financial liability derecognised and the consideration paid and payable is recognised in profit or loss.

2.15 Borrowings

Borrowings are recognised initially at fair value, net of transaction costs incurred. Borrowings are subsequently carried at amortised cost; any difference between the proceeds (net of transaction costs) and the redemption value is recognised in the Consolidated Financial Statements as finance cost over the period of the borrowings using the effective interest method.

Borrowings are classified as current liabilities unless the Group has an unconditional right to defer settlement of the liability for at least 12 months after the reporting period.

Notes to the Consolidated Financial Statements

2 SUMMARY OF SIGNIFICANT ACCOUNTING POLICIES (Continued)**2.16 Borrowing costs**

General and specific borrowing costs directly attributable to the acquisition, construction or production of qualifying assets, which are assets that necessarily take a substantial period of time to get ready for their intended use or sale, are added to the cost of those assets, until such time as the assets are substantially ready for their intended use or sale.

The capitalisation rate is the weighted average of the borrowing costs applicable to the borrowings outstanding during the period up to the amount of actual borrowing costs incurred during that period. Any specific borrowing that remains outstanding after the related asset is ready for its intended use or sale is included in the general borrowing pool for calculation of capitalisation rate on general borrowings. Investment income earned on the temporary investment of specific borrowings pending their expenditure on qualifying assets is deducted from the borrowing costs eligible for capitalisation. All other borrowing costs are recognised in profit or loss in the period in which they are incurred.

2.17 Retirement obligations

The Group has both defined contribution and defined benefit plans. Group companies operate various pension schemes. The schemes are generally funded through payments to insurance companies or trustee-administered funds, as determined by periodic actuarial calculations.

(a) Defined contribution plans

A defined contribution plan is a pension plan under which the Group pays contributions into a separate entity. The Group has no legal or constructive obligations to pay further contributions if the fund does not hold sufficient assets to pay all employees the benefits relating to prior or current employee services.

The Group pays contributions to, including but not limited to, publicly or privately administered pension insurance plans on a mandatory or voluntary basis. The Group has no further payment obligations once the contributions have been paid. The contributions are recognised as employee benefit expense when they are due. Prepaid contributions are recognised as an asset to the extent that a cash refund or a reduction in the future payments is available.

(b) Defined benefit plans

A defined benefit plan is a pension plan that is not a defined contribution plan. Typically, defined benefit plans define an amount of pension benefit that an employee will receive upon retirement, usually dependent on one or more factors such as age, years of service and compensation.

The liability recognised in the Consolidated Financial Statements in respect of defined benefit pension plans is the present value of the defined benefit obligation at the end of the reporting period less the fair value of plan assets. The defined benefit obligation is calculated annually by independent actuaries using the projected unit credit method. The salary level trend refers to the expected rate of salary increase, which is estimated annually depending on inflation and the career development of employees within the Group. The present value of the defined benefit obligation is determined by discounting the estimated future cash outflows using interest rates of high-quality corporate bonds that are denominated in the currency in which the benefits will be paid and that have terms to maturity approximating the terms of the related pension obligation. A company-specific default risk is not taken into account.

Actuarial gains and losses arising from experience adjustments and changes in actuarial assumptions are charged or credited to equity in other comprehensive income in the period in which they arise.

Notes to the Consolidated Financial Statements

2 SUMMARY OF SIGNIFICANT ACCOUNTING POLICIES (Continued)**2.17 Retirement obligations** (Continued)*(b) Defined benefit plans* (Continued)

The current service cost of the defined benefit plan is recognised in the Consolidated Financial Statements in employee benefit expense, except where included in the cost of an asset. The current service cost reflects the increase in the defined benefit obligation resulting from employee service in the current year, benefit changes, curtailments and settlements.

Past-service costs are recognised immediately in the consolidated income statement.

The net interest cost is calculated by applying the discount rate to the net balance of the defined benefit obligation and the fair value of plan assets. This cost is included in employee benefit expense in the Consolidated Financial Statements.

2.18 Current and deferred income tax

The tax (benefit) expense for the period comprises current and deferred tax. Tax is recognised in the consolidated income statement, except to the extent that it relates to items recognised in other comprehensive income or directly in equity. In this case, the tax is also recognised in other comprehensive income or directly in equity, respectively.

(a) Current income tax

The current income tax charge is calculated on the basis of the tax laws enacted or substantively enacted at the balance sheet date in the countries where the Company and the Company's subsidiaries operate and generate taxable income. Management periodically evaluates positions taken in tax returns with respect to situations in which applicable tax regulation is subject to interpretation. It establishes provisions where appropriate on the basis of amounts expected to be paid to the tax authorities.

*(b) Deferred income tax**(i) Inside basis differences*

Deferred income tax is recognised, using the balance sheet liability method, on temporary differences arising between the tax basis of assets and liabilities and their carrying amounts in the Consolidated Financial Statements. Deferred income tax is determined using tax rates (and laws) that have been enacted or substantively enacted by the balance sheet date and are expected to apply when the related deferred income tax asset is realised or the deferred income tax liability is settled.

Deferred income tax assets are recognised only to the extent that it is probable that future taxable profit will be available against which the temporary differences can be utilised.

(ii) Outside basis differences

Deferred income taxes are recognised on temporary differences arising on investments in subsidiaries and joint arrangements, except where the Group is able to control the timing of the reversal of the temporary difference and it is probable that the temporary difference will not reverse in the foreseeable future.

Notes to the Consolidated Financial Statements

2 SUMMARY OF SIGNIFICANT ACCOUNTING POLICIES (Continued)**2.18 Current and deferred income tax** (Continued)*(c) Offsetting*

Deferred income tax assets and liabilities are offset when there is a legally enforceable right to offset current tax assets against current tax liabilities and when the deferred income tax assets and liabilities relate to income taxes levied by the same taxation authority on either the taxable entity or different taxable entities where there is an intention to settle the balances on a net basis.

(d) Uncertainty over income tax treatments

In assessing any uncertainty over income tax treatments, the Group considers whether it is probable that the relevant tax authority will accept the uncertain tax treatment used, or proposed to be used by individual group entities in their income tax filings. If it is probable, the current and deferred taxes are determined consistently with the tax treatment in the income tax filings. If it is not probable that the relevant taxation authority will accept an uncertain tax treatment, the effect of each uncertainty is reflected by using either the most likely amount or the expected value.

2.19 Provisions

Provisions for restructuring, litigation, environmental liabilities, warranties, decommissioning and other are recognised when: the Group has a present legal or constructive obligation as a result of past events; it is probable that an outflow of resources will be required to settle the obligation; and the amount of the obligation can be reliably estimated. Restructuring provisions primarily comprise employee payments. Provisions are not recognised for future operating losses.

Provisions are measured at the present value of the expenditures expected to be required to settle the obligation using a pre-tax rate that reflects current market assessments of the time value of money and the risks specific to the obligation. The increase in the provision due to passage of time is recognised as interest expense.

2.20 Trade payables

Trade payables are obligations to pay for goods or services that have been acquired in the ordinary course of business from suppliers. Trade payables are classified as current liabilities if payment is due within one year or less (or in the normal operating cycle of the business if longer). If not, they are presented as non-current liabilities.

2.21 Revenue recognition

See note 5 for details on the Group's revenue recognition policy.

2.22 Leases

The Group recognises a right-of-use asset (**ROU asset**) and lease liability on the Consolidated Financial Statements for all leases with a term longer than 12 months.

Lease liabilities are measured at the present value of lease payments that are unpaid at the commencement date, discounted using the applicable incremental borrowing rate at the beginning of the lease. IFRS 16 'Leases' (**IFRS 16**) requires that the rate implicit in the lease be used if readily determinable. Generally, implicit rates are not readily determinable in our contracts and the incremental borrowing rate is used for each lease arrangement. The incremental borrowing rates are determined using rates specific to the term of the lease, economic environments where lease activity is concentrated, value of lease portfolio, and assuming full collateralisation of the loans.

ROU assets are measured at cost, less accumulated depreciation and any accumulated impairment losses. Any remeasurement of a specific lease liability results in a corresponding adjustment to the ROU asset. The adjustment can be positive or negative. Depreciation of the ROU asset is calculated in accordance with IAS 16 'Property, Plant and Equipment', and is recorded straight-line over the shorter of the lease term and the useful life of the ROU asset.

Notes to the Consolidated Financial Statements

2 SUMMARY OF SIGNIFICANT ACCOUNTING POLICIES (Continued)

2.22 Leases (Continued)

For all asset classes, the Group accounts for each lease component of a contract and its associated non-lease components as a single lease component, rather than allocating a stand-alone value to each component of the lease. The Group does not apply the use of hindsight when determining the lease term and assessing ROU assets for impairment. The Group does not recognise ROU assets and lease liabilities for short-term leases that have a lease term of 12 months or less and leases of low-value assets. The Group recognises the lease payments associated with these leases as an expense on a straight-line basis over the lease term.

For the purpose of calculating lease obligations, the Group's lease terms may include options to extend or terminate the lease when it is reasonably certain that the Group will exercise such option. The Group's leases do not contain material residual value guarantees or material restrictive covenants.

The majority of the Group's global lease portfolio represents leases of real-estate, such as manufacturing facilities and office buildings, while the remainder represents leases of personal property, such as machinery and equipment and furniture and office equipment. The Group determines if an arrangement contains a lease at inception. The majority of the Group's lease arrangements are comprised of fixed payments and a limited number of these arrangements include a variable payment component based on certain index fluctuations.

2.23 Share-based payment

The Group established an equity-settled, share-based compensation plan in June 2014, under which the Group receives services from certain employees as consideration for equity instruments (options) of the Group. The fair value of the employee services received in exchange for the grant of the options is recognised as an expense with a corresponding increase in equity (**share-based compensation reserve**). The total amount to be expensed is determined by reference to the fair value of the options granted, excluding the impact of any non-market performance and service vesting conditions (for example, profitability, sales growth targets and remaining an employee of the entity over a specified time period).

When the options are exercised, the Group issues new shares. The proceeds received net of any directly attributable transaction costs are credited to share capital (nominal value) and share premium.

The Group established performance awards in November 2020 and June 2021, under which the Group receives services from certain employees as consideration for performance awards that are indexed to the share price of the Group. The fair value of the employee services received in exchange for the grant of the performance award is recognised as an expense and a corresponding liability. The total amount to be expensed is determined by reference to the positive difference between the stock price on the vesting date and the initial stock price for the performance award.

Non-market performance, if any, and service conditions are included in assumptions about the number of options and performance awards that are expected to vest. The total expense is recognised over the vesting period, which is the period over which all the specified vesting conditions are to be satisfied.

At the end of each reporting period, the Group revises its estimates of the number of options and performance awards that are expected to vest based on the non-market performance, if any, and service conditions. It recognises the impact of the revision to original estimates, if any, in the Consolidated Financial Statements, with a corresponding adjustment to equity for the options and liability for the performance awards.

Notes to the Consolidated Financial Statements

2 SUMMARY OF SIGNIFICANT ACCOUNTING POLICIES (Continued)**2.24 Government grants**

The Group periodically receives government grants in support of various business initiatives. Grants from the government are recognised at their fair value where there is reasonable assurance that the grant will be received and the Group will comply with all attached conditions. Government grants used to purchase, construct or otherwise acquire property, plant and equipment are deducted from the cost of the related asset. Government grants that are receivable as compensation for expenses or losses already incurred or for the purpose of giving immediate financial support to the Group with no future related costs are recognised as income in the period in which they become receivable.

2.25 Dividend distribution

Dividend distribution to the Company's shareholders is recognised as a liability in the Group's and the Company's financial statements in the period in which the dividends are appropriately authorised and no longer at the discretion of the Group or the Company.

2.26 New/revised standards, amendments to standards and interpretations*(a) New and amended standards adopted by the Group*

The Group has adopted the following amendments which are relevant to the Group and mandatory for the accounting period beginning on January 1, 2021.

Amendments to IAS 39, IFRS 4, IFRS 7, IFRS 9 and IFRS 16	Interest Rate Benchmark Reform – Phase 2
Amendment to IFRS 16	Leases – COVID-19-Related Rent Concessions

The adoption of these amendments did not have a significant effect on the Consolidated Financial Statements.

(b) New and amended standards and interpretations not yet adopted by the Group

The following new standards, amendments to standards and interpretations relevant to the Group have been issued but are not yet effective for the financial year beginning January 1, 2021 and have not been early adopted:

Amendment to IFRS 16	Leases – COVID-19-Related Rent Concessions beyond June 30, 2021 ⁽ⁱ⁾
Amendments to IAS 1	Classification of Liabilities as Current or Non-current ⁽ⁱⁱⁱ⁾
Amendments to IAS 1 and IFRS Practice Statement 2	Disclosure of Accounting Policies ⁽ⁱⁱⁱ⁾
Amendments to IAS 8	Definition of Accounting Estimates ⁽ⁱⁱⁱ⁾
Amendments to IAS 12	Deferred Tax related to Assets and Liabilities arising from a Single Transaction ⁽ⁱⁱⁱ⁾
Amendments to IAS 16	Property, Plant and Equipment: Proceeds before Intended Use ⁽ⁱⁱ⁾
Amendments to IAS 37	Provisions, Contingent Liabilities and Contingent Assets: Onerous Contracts – Costs of Fulfilling a Contract ⁽ⁱⁱ⁾
Amendments to IFRS Standards	Annual Improvements to IFRS Standards 2018 - 2020 ⁽ⁱⁱⁱ⁾

Notes:

(i) Effective for annual periods beginning on or after April 1, 2021

(ii) Effective for annual periods beginning on or after January 1, 2022

(iii) Effective for annual periods beginning on or after January 1, 2023

Management has assessed the application of the above new and amended standards and interpretations relevant to the Group and anticipate that there is no material impact on the Consolidated Financial Statements.

Notes to the Consolidated Financial Statements

3 FINANCIAL RISK MANAGEMENT

3.1 Financial risk factors

The Group's activities expose it to a variety of financial risks: market risk (including foreign exchange risk and cash flow interest rate risk), credit risk and liquidity risk. The Group's overall risk management programme focuses on the unpredictability of financial markets and seeks to minimise potential adverse effects on the Group's financial performance.

The Group's treasury department focuses on minimising potential adverse effects on the Group's financial performance.

(a) Market risk

The objective of market risk management is to manage and control market risk exposures within acceptable parameters while optimising the return.

(i) Foreign exchange risk

The Group operates internationally but is exposed to limited foreign exchange risk arising from various currency exposures. Management monitors and analyses expected exchange rate developments and considers hedging foreign currency exposure should the need arise.

(ii) Cash flow and fair value interest rate risk

The Group's interest rate risk primarily arises from current and non-current borrowings. Changes in interest rates on borrowings issued at variable rates expose the Group to cash flow interest rate risk. Borrowings obtained at fixed rates expose the Group to fair value interest rate risk. As at December 31, 2021, all of the Group's outstanding borrowings were in floating rate instruments, however, as at December 31, 2020, all of the Group's outstanding borrowings were in fixed rate instruments with undrawn facilities with floating interest rates. In the event there is a change in market conditions the Group will assess the costs and benefits of both variable and fixed rate borrowings and entering into interest rate swaps. The Group does not currently hold any interest rate swaps.

As at December 31, 2021, if the interest rates had been 100 basis points higher (lower) than the prevailing rate, with all other variables held constant, profit before income tax for the year ended December 31, 2021 would have been US\$984,000 (2020: US\$425,000) lower (higher).

(b) Credit risk

The Group sells to automotive manufacturers throughout the world. Credit risk arises from deposits with banks and financial institutions as well as credit exposures to customers, including outstanding receivables. The treasury department is responsible for managing and analysing the credit risk for each new customer before standard payment and delivery terms and conditions are offered. The customer's creditworthiness is assessed based on a number of variables.

The Group considers the probability of default upon initial recognition of an asset and whether there has been a significant increase in credit risk on an on-going basis throughout each reporting period. Financial assets are written off when there is no reasonable expectation of recovery, such as the debtor failing to engage in a repayment plan with the Group. Where financial assets have been written off, the Group continues to engage in enforcement activity to attempt to recover the receivable due. Where recoveries are made, these are recognised in profit or loss.

Notes to the Consolidated Financial Statements

3 FINANCIAL RISK MANAGEMENT (Continued)**3.1 Financial risk factors** (Continued)*(b) Credit risk* (Continued)

The Group's largest customer is General Motors Company and subsidiaries (**GM**) and its affiliates, which comprised 32% of revenues during the year ended December 31, 2021 (2020: 35%). Trade receivables from GM and its affiliates was 26% of total trade receivables as at December 31, 2021 (December 31, 2020: 33%).

The Group monitors the credit ratings of its banks and financial institutions. As at December 31, 2021, the Group holds approximately 81% (December 31, 2020: 82%) of its cash in financial institutions with credit ratings of A3 (Moody's) or higher, meaning the institutions have a very strong to extremely strong capacity to meet financial commitments. The majority of the remaining cash is held in banks within investment grade.

(c) Liquidity risk

The Group monitors forecasts of liquidity requirements to ensure it has sufficient cash to meet operational needs, while maintaining sufficient availability on its undrawn committed borrowing facilities as to not breach borrowing limits or covenants (where applicable) on any of its facilities. The Group's forecasting takes into consideration debt financing plans, covenant compliance and if applicable, external regulatory or legal requirements.

The tables below analyse the Group's financial liabilities and lease liabilities. The categories are based on the remaining period as at the balance sheet date to the contractual maturity date. The amounts disclosed are the contractual undiscounted cash flows including principal and interest.

	Within 1 year US\$'000	1–2 years US\$'000	2–5 years US\$'000	Over 5 years US\$'000
As at December 31, 2021				
Short-term borrowings	84,403	–	–	–
Lease liabilities	15,226	12,071	28,209	16,690
	99,629	12,071	28,209	16,690
Trade payables	666,501	–	–	–
Other payables and accruals	56,353	5,296	–	–
	722,854	5,296	–	–
As at December 31, 2020				
Short-term borrowings	264,688	–	–	–
Lease liabilities	16,475	14,331	25,878	10,361
	281,163	14,331	25,878	10,361
Trade payables	657,155	–	–	–
Other payables and accruals	63,334	5,683	–	–
	720,489	5,683	–	–

Notes to the Consolidated Financial Statements

3 FINANCIAL RISK MANAGEMENT (Continued)**3.2 Capital management**

The Group's objectives when managing capital are to safeguard the Group's ability to continue as a going concern in order to provide returns to shareholders and maintain an optimal capital structure to reduce the cost of capital. The Group monitors the gearing ratio to evaluate capital efficiency. Gearing ratio is a rate of total borrowings divided by total equity at the end of each year and is displayed as follows:

	As at December 31,	
	2021 US\$'000	2020 US\$'000
Total borrowings (note 16)	84,403	248,636
Total equity	2,002,589	1,920,985
Gearing ratio	4.2%	12.9%

3.3 Fair value estimation

The carrying amounts of the Group's current financial assets and liabilities, including cash and cash equivalents, restricted bank deposits, trade receivables and other receivables, trade payables and other payables and current borrowings approximate their fair values. The fair value of financial liabilities for disclosure purposes is estimated by discounting the future contractual cash flows at the current market interest rate available to the Group for similar financial instruments.

As set out in notes 2.9, 11 and 20, the Group has notes receivable measured at FVOCI and included in Level 2 of the fair value hierarchy as at December 31, 2021 and December 31, 2020. Notes receivable are measured at FVOCI as (i) they are held within a business model whose objective is achieved by collecting contractual cash flows and selling financial assets; and (ii) the contractual terms of the financial asset give rise on specified dates to cash flows that are solely payments of principal and interest on the principal amount outstanding. The fair value of financial assets at FVOCI is estimated by discounting the future contracted cash flows at the current market interest rate that is available to the Group for similar financial instruments. The Group had no other financial assets or liabilities measured at fair value as at December 31, 2021 and December 31, 2020. The different levels are defined as follows:

- The fair value of financial instruments traded in active markets is based on quoted market prices at the balance sheet date. A market is regarded as active if quoted prices are readily and regularly available from an exchange, dealer, broker, industry group, pricing service or regulatory agency; and those prices represent actual and regularly occurring market transactions on an arm's length basis. The quoted market price used for financial assets held by the Group is the current bid price. These instruments are included in **Level 1**.
- The fair value of financial instruments that are not traded in an active market is determined by using valuation techniques. These valuation techniques maximise the use of observable market data where it is available and rely as little as possible on entity specific estimates. If all significant inputs required to fair value an instrument are observable, the instrument is included in **Level 2**.
- If one or more of the significant inputs is not based on observable market data, the instrument is included in **Level 3**.

There were no transfers of financial assets or financial liabilities between fair value hierarchy classifications.

Notes to the Consolidated Financial Statements

4 CRITICAL ACCOUNTING ESTIMATES AND JUDGEMENTS

Estimates and judgements are continually evaluated and are based on historical experience and other factors, including expectations of future events that are believed to be reasonable under the circumstances.

The Group makes estimates and assumptions concerning the future. The resulting accounting estimates will, by definition, seldom equal the related actual results. In addition, management has applied judgements in the process of applying the Group's accounting policies. The estimates and assumptions that have a significant risk of causing a material adjustment to the carrying amounts of assets and liabilities, and the critical judgement in applying accounting policies that have significant effect on amounts recognised in the Consolidated Financial Statements are addressed below.

(a) Intangible assets not available for use

(i) Capitalisation

Costs incurred on development projects are recognised as intangible assets when it is probable that the projects will be successful considering the criteria set out in note 2.7. The Group's development activities are tracked and documented to support the basis of determining if and when the criteria were met.

(ii) Impairment

The Group is required to test for impairment of intangible development assets not available for use on an annual basis. The recoverable amount is determined based on the higher of fair value less cost to sell and value in use.

Determination of the value in use is an area involving management judgement in order to assess whether the carrying value of the intangible development assets not available for use can be supported by the net present value of future cash flows specific to each development asset. In calculating the net present value of the future cash flows, certain assumptions are required to be made in respect of highly uncertain matters including management's expectations of future unlevered free cash flows and the selection of discount rates to reflect the risks involved.

The Group uses the most recent detailed calculation of that asset's recoverable amount made in a preceding period when all of the following criteria are met: the assets and liabilities of the Group have not changed significantly from the most recent calculation; the most recent calculation resulted in an amount that exceeded the asset's carrying amount by a substantial margin; and based on an analysis of events that have occurred and circumstances that have changed since the most recent calculation, the likelihood that a current recoverable amount determination would be less than the asset's carrying amount is remote.

Notes to the Consolidated Financial Statements

4 CRITICAL ACCOUNTING ESTIMATES AND JUDGEMENTS (Continued)**(b) Warranty provisions**

The Group recognises a provision when there is a present obligation from a past event, a transfer of economic benefits is probable and the amount of costs of the transfer can be estimated reliably.

The Group recognises expected warranty costs for products sold principally at the time of sale of the product or when it is determined that such obligations are probable and can be reasonably estimated. Amounts recorded are based on the Group's estimates of the amount that will eventually be required to settle such obligations. These accruals are based on factors such as specific customer arrangements, past experience, production changes, industry developments and various other considerations. The Group's estimates are adjusted from time to time based on facts and circumstances that impact the status of existing claims.

(c) Income taxes

During the year ended December 31, 2021, the Group reached final agreement with the taxing authority that certain dividends declared and paid by a subsidiary of the Company were subject to withholding tax under the tax law at the time of such dividend payments in the amount of US\$2,429,000 and related interest of US\$929,000 which were recorded as income tax expense and finance costs, respectively, in the Consolidated Financial Statements for the year ended December 31, 2021.

Furthermore, the Group is subject to income taxes in numerous jurisdictions. Significant judgement is required in determining the worldwide provision for income taxes. There are many transactions and calculations for which the ultimate tax determination is uncertain. The Group recognises liabilities for anticipated tax audit issues based on estimates of whether additional taxes will be due. The Group believes that its accruals for tax liabilities are adequate for all open audit years based on its assessment of many factors including past experience and interpretations of tax law. This assessment relies on estimates and assumptions and may involve a series of complex judgements about future events. Where the final tax outcome of these matters is different from the amounts that were initially recorded, such differences will impact the current and deferred income tax assets and liabilities in the period in which such determination is made.

Deferred tax assets are recognised only if it is probable that taxable profits will be available against which the deductible temporary differences can be utilised. This determination requires significant judgement regarding the realisability of deferred tax assets. For entities with a recent history of losses, there would need to be convincing other evidence that sufficient taxable profits would be available in the future. When the expectation is different from the original estimate, such differences will impact the recognition of deferred income tax assets and taxation charges in the period in which such estimate is changed.

Notes to the Consolidated Financial Statements

5 REVENUE AND SEGMENT INFORMATION**5.1 Revenue from contracts with customers**

The Group contracts with customers, which are generally automotive manufacturers and automotive original equipment manufacturers, to sell steering and driveline systems and components. In connection with these contracts the Group also provides tooling and prototype parts. The Group does not have material significant payment terms as payment is received shortly after the point of sale.

Performance obligations

The following summarises types of performance obligations identified in a contract with a customer.

Products	Nature, timing of satisfaction of performance obligations, and payment terms.
Production Parts	<p>The Group recognises the majority of revenue for production parts at a point in time upon shipment to the customer and transfer of the title and risk of loss under standard commercial terms.</p> <p>A limited number of the Group's customer arrangements for customised products with no alternative use provide the Group with the right to payment during the production process. These revenues are recognised over time using the input method as performance obligations under the terms of a contract are satisfied.</p> <p>The amount of revenue recognised is based on the purchase order price. Customers typically pay for the product/prototype based on customary business practices with payment terms ranging from 30 to 90 days.</p>
Tooling	<p>The Group's development and sale of tooling for customers is performed in connection with the preparations to produce and sell products to its customers. Customers typically pay for the tooling in a lump sum upon acceptance.</p> <p>The Group recognises revenue for tooling over time using the input method as it satisfies its performance obligation. Revenue is recognised to the extent of costs incurred to date for reimbursable tooling from customers.</p>
Engineering Design and Development/Prototypes	<p>The Group recognises non-production related engineering design and development revenue, which is normally related to ADAS, performance improvement and business pursuit.</p> <p>The Group recognises revenue for non-production engineering design and development/prototypes revenue over time using the input method as it satisfies its performance obligations.</p>

Notes to the Consolidated Financial Statements

5 REVENUE AND SEGMENT INFORMATION (Continued)**5.1 Revenue from contracts with customers** (Continued)*Contract balances*

The contract assets primarily relate to the Group's rights to consideration for work completed but not billed at the reporting date on production parts, tooling and engineering design and development/prototypes. The contract assets are reclassified into the receivables balance when the rights to receive payment become unconditional. Contract assets are assessed for impairment under the expected credit loss method in IFRS 9. There have been no impairment losses recognised related to contract assets arising from the Group's contracts with customers. Contract liabilities are associated with consideration received from customers in advance of transferring goods promised in a contract. Recognition of revenue is deferred until the related performance obligations are satisfied in the future. The following table provides information about contract assets and contract liabilities from contracts with customers.

	Contract assets ⁽ⁱ⁾ US\$'000	Contract liabilities, Current ⁽ⁱⁱ⁾ US\$'000	Contract liabilities, Non-current ⁽ⁱⁱ⁾ US\$'000
Balances as at December 31, 2021	43,791	23,691	86,737
Balances as at December 31, 2020	41,664	21,645	69,071
Change in account balance	2,127	2,046	17,666

(i) Contract assets are recorded within other current receivables and prepayments. As at January 1, 2020, contract assets amounted to US\$33,572,000 in total.

(ii) Contract liabilities are recorded within deferred revenue. As at January 1, 2020, contract liabilities amounted to US\$104,317,000 in total.

5.2 Segment information

The Group's segment information is presented on the basis of internal reports that are regularly reviewed by the Group's CEO in order to allocate resources to the segments and assess their performance. For each of the Group's reportable segments, the Group's CEO reviews internal management reports on a quarterly basis.

The Group classifies its businesses into three reportable segments: North America, Asia Pacific, and Europe, Middle East, Africa and South America (**EMEASA**). All of the Group's operating segments typically offer the same steering and driveline products. The 'Others' category represents parent company activities of the Company and activities of its non-operating direct and indirect subsidiaries, as well as elimination entries between segments.

Notes to the Consolidated Financial Statements

5 REVENUE AND SEGMENT INFORMATION (Continued)**5.2 Segment information** (Continued)

The key performance indicators that the Group monitors to manage segment operations are:

- Operating income before interest, taxes, depreciation and amortisation (including reversal of impairment/impairment on property, plant and equipment and intangible assets) and share of results of joint ventures (**Adjusted EBITDA**).
- Total assets and total liabilities represent total current and non-current assets and total current and non-current liabilities of the segments and include assets and liabilities between operating segments.

Information about reportable segments and reconciliations of reportable segment revenues is as follows:

	North America US\$'000	Asia Pacific US\$'000	EMEASA US\$'000	Others US\$'000	Total US\$'000
For the year ended December 31, 2021					
Total revenue	1,977,545	839,954	587,146	–	3,404,645
Inter-segment revenue	(13,822)	(30,465)	(1,633)	–	(45,920)
Revenue from external customers	1,963,723	809,489	585,513	–	3,358,725
Adjusted EBITDA	164,294	151,005	37,609	7,855	360,763
For the year ended December 31, 2020					
Total revenue	1,919,325	662,675	487,457	–	3,069,457
Inter-segment revenue	(14,193)	(21,246)	(1,808)	–	(37,247)
Revenue from external customers	1,905,132	641,429	485,649	–	3,032,210
Adjusted EBITDA	234,748	125,157	25,537	(7,430)	378,012

The revenue from external parties reported to the Group's CEO is measured in a manner consistent with that in the Consolidated Financial Statements.

Reconciliations of reportable segment total assets and liabilities are as follows:

	North America US\$'000	Asia Pacific US\$'000	EMEASA US\$'000	Others US\$'000	Total US\$'000
As at December 31, 2021					
Total assets	1,950,573	993,050	495,148	(232,272)	3,206,499
Total liabilities	746,943	385,554	247,416	(176,003)	1,203,910
As at December 31, 2020					
Total assets	1,940,556	1,071,161	499,523	(205,499)	3,305,741
Total liabilities	694,149	347,863	241,282	101,462	1,384,756

Notes to the Consolidated Financial Statements

5 REVENUE AND SEGMENT INFORMATION (Continued)**5.2 Segment information** (Continued)

Reconciliations of reportable segment Adjusted EBITDA to the Group's profit before income tax are as follows:

	For the year ended December 31,	
	2021 US\$'000	2020 US\$'000
Adjusted EBITDA from reportable segments	360,763	378,012
Depreciation and amortisation expenses	(252,757)	(228,575)
Reversals of (impairments) on property, plant and equipment and intangible assets	7,209	(30,710)
Finance income	4,426	4,096
Finance costs	(6,281)	(9,156)
Share of results of joint ventures	653	795
Profit before income tax	114,013	114,462

In presenting information on the basis of geography, segment revenue is based on the geographical location of subsidiaries and segment assets and liabilities are based on geographical location of the assets.

Adjusted EBITDA includes a non-cash component for revenue recognised from deferred revenue. For the year ended December 31, 2021, the North America segment and Asia Pacific segment recognised US\$18,741,000 (2020: US\$21,640,000) and US\$604,000 (2020: US\$12,195,000), respectively.

The geographic distribution of revenue for the years ended December 31, 2021 and 2020 is as follows:

	For the year ended December 31,	
	2021 US\$'000	2020 US\$'000
North America:		
US	1,170,664	1,092,048
Mexico	793,059	813,084
Asia Pacific:		
China	686,098	571,152
Rest of Asia Pacific	123,391	70,277
EMEASA:		
Poland	365,950	347,353
Rest of EMEASA	219,563	138,296
Total	3,358,725	3,032,210

Notes to the Consolidated Financial Statements

5 REVENUE AND SEGMENT INFORMATION (Continued)**5.2 Segment information** (Continued)

The geographic distribution of non-current assets excluding deferred income tax assets as at December 31, 2021 and 2020 is as follows:

	As at December 31,	
	2021 US\$'000	2020 US\$'000
North America:		
US	1,017,273	973,702
Mexico	277,756	275,965
Asia Pacific:		
China	282,280	277,330
Rest of Asia Pacific	31,003	30,270
EMEASA:		
Poland	153,674	171,143
Rest of EMEASA	70,488	68,002
Others	2,439	1,517
	1,834,913	1,797,929

Disaggregation of revenue

	North America US\$'000	Asia Pacific US\$'000	EMEASA US\$'000	Total US\$'000
For the year ended December 31, 2021				
Electric Power Steering (EPS)	1,281,116	526,451	517,935	2,325,502
Steering Columns and Intermediate Shafts (CIS)	293,916	15,794	8,076	317,786
Hydraulic Power Steering (HPS)	120,119	2,280	14,549	136,948
Driveline Systems (DL)	268,572	264,964	44,953	578,489
	1,963,723	809,489	585,513	3,358,725

	North America US\$'000	Asia Pacific US\$'000	EMEASA US\$'000	Total US\$'000
For the year ended December 31, 2020				
EPS	1,165,793	431,064	461,327	2,058,184
CIS	326,242	12,351	4,928	343,521
HPS	106,398	3,088	10,534	120,020
DL	306,699	194,926	8,860	510,485
	1,905,132	641,429	485,649	3,032,210

Notes to the Consolidated Financial Statements

5 REVENUE AND SEGMENT INFORMATION (Continued)**5.2 Segment information** (Continued)*Revenue by Type*

	For the year ended December 31,	
	2021 US\$'000	2020 US\$'000
Production parts	3,311,240	2,997,133
Tooling	32,914	29,553
Engineering design and development/prototypes	14,571	5,524
	3,358,725	3,032,210

Customers amounting to 10 percent or more of the Group's revenue are as follows and reported in North America, Asia Pacific and EMEASA segments:

	For the year ended December 31,	
	2021 US\$'000	2020 US\$'000
GM	1,069,513	1,069,939
Customer A ⁽ⁱ⁾	906,206	810,527
Customer B	559,709	524,104
	2,535,428	2,404,570

Note:

- (i) Subsequent to December 31, 2020, customer A merged with another customer of the Group. Revenue from customer A for the year ended December 31, 2020 has been updated to include revenue from the other party to the merger.

Notes to the Consolidated Financial Statements

6 PROPERTY, PLANT AND EQUIPMENT

	Freehold land and land improvement US\$'000	Leasehold improvements US\$'000	Buildings US\$'000	Machinery, equipment and tooling US\$'000	Furniture and office equipment US\$'000	Construction- in-progress US\$'000	Total US\$'000
As at January 1, 2020							
Cost	12,855	20,469	64,563	1,378,037	5,665	156,411	1,638,000
Accumulated depreciation	(2,446)	(11,867)	(16,072)	(615,431)	(2,430)	-	(648,246)
Net book amount	10,409	8,602	48,491	762,606	3,235	156,411	989,754
Year ended December 31, 2020							
Opening net book amount	10,409	8,602	48,491	762,606	3,235	156,411	989,754
Additions, net ⁽ⁱ⁾	457	1,962	27,701	141,496	2,484	(47,083)	127,017
Reversal of Impairment	-	-	-	-	-	3,437	3,437
Disposals	-	(3)	(537)	(11,690)	(82)	-	(12,312)
Depreciation	(179)	(2,487)	(2,582)	(115,935)	(827)	-	(122,010)
Exchange differences	40	219	2,310	16,115	256	4,507	23,447
Net book amount as at December 31, 2020	10,727	8,293	75,383	792,592	5,066	117,272	1,009,333
As at January 1, 2021							
Cost	13,410	20,288	93,241	1,512,538	8,006	117,272	1,764,755
Accumulated depreciation	(2,683)	(11,995)	(17,858)	(719,946)	(2,940)	-	(755,422)
Net book amount	10,727	8,293	75,383	792,592	5,066	117,272	1,009,333
Year ended December 31, 2021							
Opening net book amount	10,727	8,293	75,383	792,592	5,066	117,272	1,009,333
Additions, net ⁽ⁱ⁾	331	1,733	758	146,455	3,015	(20,697)	131,595
Disposals	(15)	(149)	(54)	(5,422)	(169)	-	(5,809)
Depreciation	(213)	(1,901)	(2,872)	(128,174)	(905)	-	(134,065)
Exchange differences	(223)	(17)	(673)	(8,205)	(12)	(3,028)	(12,158)
Net book amount as at December 31, 2021	10,607	7,959	72,542	797,246	6,995	93,547	988,896
As at December 31, 2021							
Cost	13,406	19,979	92,779	1,619,165	10,721	93,547	1,849,597
Accumulated depreciation	(2,799)	(12,020)	(20,237)	(821,919)	(3,726)	-	(860,701)
Net book amount	10,607	7,959	72,542	797,246	6,995	93,547	988,896

Notes:

- (i) Upon completion, transfers from construction-in-progress to other classes of property, plant and equipment are included in additions, net.

Notes to the Consolidated Financial Statements

6 PROPERTY, PLANT AND EQUIPMENT (Continued)

Certain of the Group's property, plant and equipment have been pledged as collateral under the Group's borrowing arrangements. The carrying amounts of property, plant and equipment pledged as collateral were US\$320,541,000 as at December 31, 2021 (December 31, 2020: US\$389,056,000).

Depreciation has been charged to the following function of expenses:

	For the year ended December 31,	
	2021 US\$'000	2020 US\$'000
Cost of sales	117,185	106,868
Engineering and product development costs	10,010	8,893
Administrative expenses	6,870	6,249
	134,065	122,010

During the year ended December 31, 2020, the Group recorded a reversal of impairment of US\$3,437,000 within costs of sales in the EMEASA segment on construction-in-progress related to items that had been impaired in prior years, for which an alternative use was identified in 2020 and the assets were placed in service.

The additions to property, plant and equipment for the year ended December 31, 2021 include US\$28,000 of capitalised borrowing costs (2020: US\$280,000). Borrowing costs were capitalised at the weighted average of the borrowing rates of 4.4% for the year ended December 31, 2021 (2020: 6.4%).

7 LEASES

The Group's leases are mainly comprised of real-estate and vehicles. Information about leases for which the Group is a lessee is presented below.

Right-of-use assets

	Real-Estate US\$'000	Other US\$'000	Total US\$'000
Balance as at December 31, 2020	48,883	8,456	57,339
Depreciation charge for the year ended December 31, 2020	11,366	1,842	13,208
Balance as at December 31, 2021	56,511	6,878	63,389
Depreciation charge for the year ended December 31, 2021	11,364	2,030	13,394

Additions to the right-of-use assets during the year ended December 31, 2021 were US\$21,357,000 (year ended December 31, 2020: US\$7,611,000).

Notes to the Consolidated Financial Statements

7 LEASES (Continued)**Right-of-use assets** (Continued)

Depreciation has been charged to the following function of expenses:

	For the year ended December 31,	
	2021 US\$'000	2020 US\$'000
Cost of sales	8,848	8,678
Engineering and product development costs	1,985	2,038
Administrative expenses	2,561	2,492
	13,394	13,208

Lease liabilities

(a) Gross lease liabilities – minimum lease payments:

	As at December 31, 2021 US\$'000	As at December 31, 2020 US\$'000
	Within 1 year	15,226
Between 1 and 2 years	12,071	14,331
Between 2 and 5 years	28,209	25,878
Over 5 years	16,690	10,361
	72,196	67,045
Less: future finance charges	(9,834)	(9,691)
	62,362	57,354

(b) Present value of lease liabilities:

	As at December 31, 2021 US\$'000	As at December 31, 2020 US\$'000
	Within 1 year	12,390
Between 1 and 2 years	9,728	11,850
Between 2 and 5 years	24,598	22,236
Over 5 years	15,646	9,741
	62,362	57,354
Less: non-current portion	(49,972)	(43,827)
	12,390	13,527

For the year ended December 31, 2021, the Group recognised interest expense on lease liabilities of US\$3,201,000 (year ended December 31, 2020: US\$3,574,000) in the Consolidated Financial Statements.

For the year ended December 31, 2021, the Group's total cash outflow for leases amounted to US\$13,709,000 (year ended December 31, 2020: US\$13,672,000).

Notes to the Consolidated Financial Statements

8 INTANGIBLE ASSETS

	Product development costs US\$'000	Computer software development costs US\$'000	Total US\$'000
Cost			
As at January 1, 2020	1,048,217	27,206	1,075,423
Additions	154,249	46	154,295
Impairment	(34,147)	–	(34,147)
Exchange differences	5,588	–	5,588
As at December 31, 2020	1,173,907	27,252	1,201,159
Accumulated amortisation			
As at January 1, 2020	426,206	22,070	448,276
Amortisation	90,483	2,874	93,357
Exchange differences	2,033	–	2,033
As at December 31, 2020	518,722	24,944	543,666
Net book amount			
As at December 31, 2020	655,185	2,308	657,493
Cost			
As at January 1, 2021	1,173,907	27,252	1,201,159
Additions	156,385	14	156,399
Impairment	(1,465)	–	(1,465)
Exchange differences	2,646	–	2,646
As at December 31, 2021	1,331,473	27,266	1,358,739
Accumulated amortisation			
As at January 1, 2021	518,722	24,944	543,666
Amortisation	103,976	1,322	105,298
Exchange differences	968	–	968
As at December 31, 2021	623,666	26,266	649,932
Net book amount			
As at December 31, 2021	707,807	1,000	708,807

The additions for the year ended December 31, 2021 include US\$9,691,000 of capitalised interest related to the borrowings associated with product development costs (2020: US\$16,280,000). Borrowing costs were capitalised at the weighted average of the borrowing rates of 4.4% for the year ended December 31, 2021 (2020: 6.4%).

Notes to the Consolidated Financial Statements

8 INTANGIBLE ASSETS (Continued)

Amortisation has been charged to the following function of expenses:

	For the year ended December 31,	
	2021 US\$'000	2020 US\$'000
Cost of sales	104,385	92,319
Administrative expenses	913	1,038
	105,298	93,357

Impairment tests

Capitalised product development costs not yet available for use amounting to US\$238,600,000 as at December 31, 2021 (December 31, 2020: US\$271,000,000) are tested annually based on the recoverable amount of the cash-generating unit to which the intangible asset is related.

The recoverable amount of the cash-generating units is determined based upon value in use from the most recent detailed calculations. The value in use is estimated using the discounted cash flow approach. For significant cash-generating units, the pre-tax discount rates used for the year ended December 31, 2021 to estimate future cash flows range between 8% and 12% (year ended December 31, 2020: between 8% and 13%), which are based on an estimated weighted average cost of capital depending on geographical location and risk factors and includes estimates of country risk premiums. Estimated cash flows are based on the estimated useful life of the cash-generating unit.

In determining value in use, it is necessary to make a series of assumptions to estimate future cash flows. There is risk in future profitability such as customer volumes and commodity pricing. The assumptions for customer volumes and commodity pricing are reviewed annually as part of management's budgeting and strategic planning cycles.

The assumptions related to customer volume and timing of sales to customers may vary due to a number of factors, including variation in demand for customers' products, customers' attempts to manage their inventories, design changes, changes in customers' manufacturing strategy, etc. Accordingly, many of the Group's customers do not commit to long-term production schedules.

The assumptions related to commodity pricing may vary as raw material costs are influenced by several commodities and the volatility of these prices may have an adverse impact on the Group's business. However, to mitigate the risk the Group continues its efforts to pass material, component and supply cost increases to the Group's customers.

During the year ended December 31, 2021, the Group recorded a net reversal of product development intangible asset impairments of US\$7,209,000. The Group recorded customer recovery from previously impaired programmes of US\$8,674,000 in the Consolidated Financial Statements as engineering and product development costs with US\$5,256,000 recorded in the North America segment and US\$3,418,000 recorded in the EMEASA segment. The Group recorded impairments of US\$1,465,000 related to programme cancellations and declining volumes on specific customer programmes. The impairment is recorded in the Consolidated Financial Statements as engineering and product development costs in the Asia Pacific segment in the amount of US\$527,000 and the North America segment in the amount of US\$938,000. During the year ended December 31, 2020, the Group recorded product development intangible asset impairments of US\$34,147,000 related to programme cancellations and declining volumes on specific customer programmes. The impairment is recorded in the Consolidated Financial Statements as engineering and product development costs in the amount of US\$34,147,000 in the Asia Pacific segment and the North America segment in the amount of US\$5,100,000 and US\$29,047,000, respectively. The intangible asset impairments in the North America segment associated with global customer programmes is due to the Company's US domiciled intellectual property holdings arrangement.

Notes to the Consolidated Financial Statements

9 DEFERRED INCOME TAXES

The analysis of deferred income tax assets and deferred income tax liabilities is as follows:

	As at December 31,	
	2021 US\$'000	2020 US\$'000
Deferred income tax assets:		
To be recovered after more than 12 months	4,929	5,745
To be recovered within 12 months	21,977	18,336
	26,906	24,081
Deferred income tax liabilities:		
To be settled after more than 12 months	(42,286)	(75,124)
	(42,286)	(75,124)
Deferred income tax liabilities, net	(15,380)	(51,043)

The reconciliation of deferred income tax liabilities, net to the consolidated balance sheet is as follows:

	As at December 31,	
	2021 US\$'000	2020 US\$'000
Deferred income tax assets	11,361	11,805
Deferred income tax liabilities	(26,741)	(62,848)
Deferred income tax liabilities, net	(15,380)	(51,043)

Notes to the Consolidated Financial Statements

9 DEFERRED INCOME TAXES (Continued)

The movement in deferred income tax assets and liabilities during the year, without taking into consideration the offsetting of balances within the same tax jurisdiction, is as follows:

	Property, plant and equipment US\$'000	Retirement benefits and compensation US\$'000	Provisions and accruals US\$'000	Tax losses and credits US\$'000	Intangible assets US\$'000	Others US\$'000	Total US\$'000
Deferred income tax assets							
As at January 1, 2020	3,621	11,801	31,787	29,086	-	12,662	88,957
(Charged) credit to income statement	(152)	823	1,741	24,366	-	4,891	31,669
Credit to equity	-	539	-	-	-	-	539
Exchange differences	(119)	(92)	(172)	(22)	-	(37)	(442)
As at December 31, 2020	3,350	13,071	33,356	53,430	-	17,516	120,723
As at January 1, 2021	3,350	13,071	33,356	53,430	-	17,516	120,723
Credit (charged) to income statement	12,936	62	4,735	28,095	-	(1,344)	44,484
Credit to equity	-	(452)	-	-	-	-	(452)
Exchange differences	(10)	(8)	(14)	(2)	-	(2)	(36)
As at December 31, 2021	16,276	12,673	38,077	81,523	-	16,170	164,719
Deferred income tax liabilities							
As at January 1, 2020	(46,247)	(132)	(1,060)	-	(90,306)	(13,169)	(150,914)
(Charged) credit to income statement	(10,646)	(24)	(719)	-	(11,582)	2,216	(20,755)
Exchange differences	(32)	-	(43)	-	-	(22)	(97)
As at December 31, 2020	(56,925)	(156)	(1,822)	-	(101,888)	(10,975)	(171,766)
As at January 1, 2021	(56,925)	(156)	(1,822)	-	(101,888)	(10,975)	(171,766)
(Charged) credit to income statement	(15,964)	153	(565)	-	11,670	(3,618)	(8,324)
Exchange differences	(3)	-	(4)	-	-	(2)	(9)
As at December 31, 2021	(72,892)	(3)	(2,391)	-	(90,218)	(14,595)	(180,099)

Notes to the Consolidated Financial Statements

9 DEFERRED INCOME TAXES (Continued)

Deferred income tax assets are recognised for tax loss carry-forwards and deductible temporary differences to the extent that the realisation of the related tax benefit through future taxable profits is probable. Deferred income tax assets being calculated at applicable tax rates have not been recognised as management believes it is more likely than not that they would not be utilised before expiration as follows:

	As at December 31,	
	2021	2020
	US\$'000	US\$'000
Tax losses	15,285	15,522
Deductible temporary differences	1,855	2,540
	17,140	18,062

As at December 31, 2021, the Group has US\$8,270,000 (December 31, 2020: US\$10,108,000) of gross net operating loss (NOL) carry-forwards in the US subject to certain annual utilisation limitations, which will expire in 2030. As at December 31, 2021, the Group has US\$80,463,000 (December 31, 2020: US\$73,055,000) of non-US gross NOL carry-forwards which have various expiration dates of which a significant amount is unlimited. The Group has recognised US\$8,867,000 (December 31, 2020: US\$10,530,000) of such tax losses as deferred tax assets. The remaining tax losses of US\$79,866,000 (December 31, 2020 US\$72,633,000) have not been recognised due to unpredictability of future profit streams.

As at December 31, 2021, deferred income tax liabilities of US\$9,850,000 (December 31, 2020: US\$7,250,000) have been provided for withholding tax that would be payable on the portion of unremitted earnings of certain subsidiaries intended to be distributed in the foreseeable future and it is probable that the temporary differences will not reverse in the foreseeable future. Deferred income tax liabilities have not been recognised on the remaining unremitted earnings because the Group is able to control the timing of reversal of the temporary differences. Unremitted earnings totaled US\$1,779,928,000 as at December 31, 2021 (December 31, 2020: US\$1,659,528,000).

10 INVENTORIES

	As at December 31,	
	2021	2020
	US\$'000	US\$'000
Raw materials	205,137	158,439
Work-in-progress	38,307	32,061
Finished goods	61,140	61,902
	304,584	252,402
Less: provision for write-down	(15,952)	(18,355)
	288,632	234,047

The cost of inventories recognised as an expense and included in cost of sales for the year ended December 31, 2021 amounted to US\$2,718,211,000 (2020: US\$2,366,043,000).

The carrying amounts of inventories pledged as collateral were US\$130,265,000 as at December 31, 2021 (December 31, 2020: US\$106,043,000).

Notes to the Consolidated Financial Statements

11 TRADE RECEIVABLES

	As at December 31,	
	2021	2020
	US\$'000	US\$'000
Trade receivables, gross	573,535	570,845
Notes receivable	54,617	24,747
Less: provision for impairment	(2,074)	(2,565)
	626,078	593,027

As at January 1, 2020, trade receivables from contracts with customers and notes receivable amounted to US\$538,825,000 and US\$5,850,000, respectively.

Certain customers in China pay for goods and services through the use of notes receivable. The Group had notes receivable outstanding in the amount of US\$54,617,000 as at December 31, 2021 (December 31, 2020: US\$24,747,000). As at December 31, 2021, notes receivable totalling US\$9,398,000 (December 31, 2020: US\$9,235,000) were pledged to guarantee notes payable in the same amount recorded within trade payables as set out in note 20. As set out in notes 2.9 and 3.3, the bank notes receivable are measured at FVOCI.

Credit terms range primarily from 30 to 90 days after the invoice date depending on the customer and the geographical region. Ageing analysis of trade and notes receivable based on invoice date is as follows:

	As at December 31,	
	2021	2020
	US\$'000	US\$'000
0 to 30 days	430,460	400,588
31 to 60 days	177,563	173,045
61 to 90 days	16,361	8,721
Over 90 days	3,768	13,238
	628,152	595,592

The provision for impairment of receivables includes estimates and assessments of individual receivables based on the expected credit loss method.

Trade receivables of US\$2,074,000 were non-credit impaired as at December 31, 2021 on which provisions were made (December 31, 2020: US\$2,565,000).

Notes to the Consolidated Financial Statements

11 TRADE RECEIVABLES (Continued)

Movement on the provision for the impairment of trade receivables is as follows:

	For the year ended December 31,	
	2021 US\$'000	2020 US\$'000
As at January 1	2,565	1,721
(Reversal) addition of provision	(370)	689
Exchange differences	(121)	155
As at December 31	2,074	2,565

The carrying amounts of trade receivables pledged as collateral were US\$362,585,000 as at December 31, 2021 (December 31, 2020: US\$371,104,000).

12 OTHER RECEIVABLES AND PREPAYMENTS

	As at December 31,	
	2021 US\$'000	2020 US\$'000
Income taxes receivable	44,717	34,689
Other taxes recoverable ⁽ⁱ⁾	24,024	32,093
Prepaid assets	47,145	49,213
Contract assets ⁽ⁱⁱ⁾	43,791	41,664
Deposits to vendors	7,688	6,783
Others	2,542	2,537
	169,907	166,979
Less: non-current portion	(50,917)	(51,482)
Current portion	118,990	115,497

Notes:

- (i) Balance mainly represents value-added tax recoverable and certain incentives granted to the Group for investing capital and maintaining jobs in the state of Michigan, USA, which expired during the year ended December 31, 2020.
- (ii) As stated in note 5, the Group has contracts with customers that require revenue to be recognised over time as costs are incurred. Contract assets balance represents rights to consideration for work completed but not billed, related to production parts, reimbursable customer tooling and engineering services.

Notes to the Consolidated Financial Statements

13 RESTRICTED BANK DEPOSITS

As at December 31, 2021, restricted bank deposits of US\$9,000 (December 31, 2020: US\$12,000) are maintained with banks for issuance of letters of credit and pledges of bank borrowings.

14 CASH AND CASH EQUIVALENTS

The Group's RMB balances of US\$158,975,000 are deposited with banks in China as at December 31, 2021 (December 31, 2020: US\$163,299,000). The RMB is not a freely convertible currency. The conversion of these RMB denominated balances into foreign currencies in China is subject to rules and regulations of foreign exchange control promulgated by the China government. Cash balances denominated in RMB will be used as part of the normal operating activities in China and are classified as unrestricted cash on this basis.

15 OTHER RESERVES

	Share premium ⁽ⁱ⁾ US\$'000	Merger reserve ⁽ⁱⁱ⁾ US\$'000	Share-based compensation reserve ⁽ⁱⁱⁱ⁾ US\$'000	Exchange reserve ^(iv) US\$'000	Total other reserves US\$'000
As at January 1, 2020	–	113,000	6,916	(97,732)	22,184
Value of employee services provided under share-option scheme (note 24(a))	–	–	7	–	7
Exchange differences	–	–	–	36,461	36,461
As at December 31, 2020	–	113,000	6,923	(61,271)	58,652
Value of employee services provided under share-option scheme (note 24(a))	–	–	21	–	21
Transfer to share premium under exercise of share options	883	–	(883)	–	–
Proceeds from exercise of share options	1,804	–	–	–	1,804
Dividends paid to shareholders	(1,045)	–	–	–	(1,045)
Exchange differences	–	–	–	(25,539)	(25,539)
As at December 31, 2021	1,642	113,000	6,061	(86,810)	33,893

Notes:

(i) Share premium

Share premium of the Group represents the difference between the fair value of shares issued and their respective par value.

(ii) Merger reserve

The Company was incorporated on August 21, 2012 and the Group's reorganisation was completed on January 30, 2013. The merger reserve in the Consolidated Financial Statements as at December 31, 2021 and 2020 represent the aggregate amount of share capital of PCM US Steering Holding LLC and PCM (Singapore) Steering Holding Pte. Limited.

(iii) Share-based compensation reserve

The share-based compensation reserve comprises the value of employee services provided under the share option scheme. The reserve is relieved when options are exercised in the amount of services recognised related to those option.

(iv) Exchange reserve

Exchange reserve arises from currency translations of all group entities that have a functional currency different from the US dollar being translated into the Group's presentation currency of US dollar.

Notes to the Consolidated Financial Statements

16 BORROWINGS

	As at December 31,	
	2021 US\$'000	2020 US\$'000
Current		
Borrowings from banks		
– secured ^(1a)	84,976	–
Add: current portion of:		
– Notes ^(1b)	–	250,000
– Debt issuance costs ^(1c)	(573)	(1,364)
Total borrowings	84,403	248,636

(1) Notes:

- (a) The Group has the following significant utilised and unutilised bank facilities at the end of the reporting period:
- (i) A revolving line of credit of US\$84,976,000 as at December 31, 2021 (December 31, 2020: US\$nil) obtained by a subsidiary of the Company which bears interest at LIBOR plus a range of 1.25% to 1.75% per annum, depending on borrowing type, matures in June 2026 and is secured by trade receivables, inventories and machinery and equipment. Availability under the agreement fluctuates according to a borrowing base. In addition, outstanding amounts under the credit facility may become immediately due and payable upon certain events of default, including failure to comply with the financial covenant in the credit agreement, a fixed charge coverage ratio requirement that applies when excess availability under the credit line is less than certain thresholds, or certain other affirmative and negative covenants in the agreement. As at December 31, 2021 the Group has availability of US\$236,859,000 of the US\$325,000,000 line of credit. In June 2021, the subsidiary refinanced its US based revolving line of credit reducing interest to LIBOR plus a range of 1.25% to 1.75% per annum from LIBOR (with a floor of 0.75% per annum) plus a range of 2.00% to 2.25% per annum, and extended the maturity to June 2026 from February 2023.
 - (ii) A factoring facility with availability to borrow up to US\$45,279,000 by a subsidiary of the Company which bears interest at EURIBOR or WIBOR plus 1.50% per annum, is secured by certain receivables. As of December 31, 2021, the subsidiary has availability to borrow based on collateral up to US\$21,761,000.
 - (iii) An overdraft facility with availability to borrow up to US\$19,719,000 by a subsidiary of the Company which bears interest at EURIBOR plus 1.60% per annum or WIBOR plus 1.40% per annum, depending on the currency borrowed, is secured by property and certain receivables expires in August 2022.

Notes to the Consolidated Financial Statements

16 BORROWINGS (Continued)**(1)** Notes: (Continued)

- (a) The Group has the following significant utilised and unutilised bank facilities at the end of the reporting period: (Continued)
- (iv) A revolving line of credit with availability to borrow up to US\$2,690,000 by a subsidiary of the Company which bears interest at the Marginal Cost of Funds Based Lending Rate + 0.8% per annum, is secured by property, plant and equipment, trade receivables and inventories.
- (v) A revolving line of credit with availability to borrow up to US\$2,690,000 by a subsidiary of the Company which bears interest at the Marginal Cost of Funds Based Lending Rate + 0.4% per annum, is secured by property, plant and equipment, trade receivables and inventories.
- (b) Notes of US\$250,000,000 in aggregate principal amount of 5.875% senior unsecured notes maturing in November 2021 (**Notes**) and were redeemed early in full and withdrawal of listing became effective upon the close of business on April 14, 2021. The Group recognised a loss of US\$448,000 related to the expensing of remaining unamortised debt issuance costs upon repayment.
- (c) The Group capitalised debt issuance costs related to various borrowings as noted above. Amortisation of the debt issuance costs is recognised in the Consolidated Financial Statements as finance cost over the period of the borrowing using the effective interest method. The unamortised balance of debt issuance costs is US\$573,000 as at December 31, 2021 (December 31, 2020: US\$1,364,000).

(2) Maturity of borrowings

	As at December 31,	
	2021	2020
	US\$'000	US\$'000
Within 1 year	84,403	248,636
	84,403	248,636

(3) Weighted average annual interest rates

	As at December 31,	
	2021	2020
Bank borrowings	2.0%	2.1%
Notes	N/A	5.9%

Notes to the Consolidated Financial Statements

17 RETIREMENT BENEFITS AND COMPENSATION

	As at December 31,	
	2021 US\$'000	2020 US\$'000
Pension – defined benefit plans ^(a)	16,295	18,453
Extended disability benefits ^(b)	2,789	3,974
Workers' compensation ^(c)	7,224	6,015
	26,308	28,442
Less: non-current portion	(22,695)	(25,061)
Current portion	3,613	3,381

(a) Pension – defined benefit plans

The Group sponsors various defined benefit plans that generally provide benefits based on negotiated amounts for each year of eligible service. The Group's most significant plans are under regulatory frameworks in Mexico, Germany, France, Korea and the US. The US Supplemental Executive Retirement Plan (**US SERP**) is a frozen plan. The plans had no curtailments or settlements affecting the defined benefit obligation.

The Group employs Mercer (U.S.) Inc., an independent qualified actuary, to measure pension costs using the projected unit credit method. The amounts recognised in the Consolidated Financial Statements are determined as follows:

	For the year ended December 31, 2021			For the year ended December 31, 2020		
	Non-US plans US\$'000	US SERP US\$'000	Total US\$'000	Non-US plans US\$'000	US SERP US\$'000	Total US\$'000
Present value of funded obligations ⁽ⁱ⁾	16,628	1,331	17,959	18,658	1,519	20,177
Fair value of plan assets ⁽ⁱⁱ⁾	(1,664)	–	(1,664)	(1,724)	–	(1,724)
Deficit of funded plans	14,964	1,331	16,295	16,934	1,519	18,453

There is no current requirement for the Group to fund the deficit between the fair value of plan assets and the present value of the defined benefit plan obligations as at December 31, 2021.

Notes to the Consolidated Financial Statements

17 RETIREMENT BENEFITS AND COMPENSATION (Continued)**(a) Pension – defined benefit plans** (Continued)

(i) Movement in the present value of defined benefit obligations:

	For the year ended December 31, 2021			For the year ended December 31, 2020		
	Non-US plans US\$'000	US SERP US\$'000	Total US\$'000	Non-US plans US\$'000	US SERP US\$'000	Total US\$'000
Opening balance	18,658	1,519	20,177	16,020	1,579	17,599
Current service cost	1,277	-	1,277	1,086	-	1,086
Past-service cost	-	-	-	(93)	-	(93)
Interest cost	784	11	795	660	33	693
(Gains) losses from changes in financial assumptions	(2,042)	(24)	(2,066)	1,908	56	1,964
Experience losses (gains)	156	(6)	150	309	(3)	306
(Losses) gains from changes in demographic assumptions	1	-	1	(33)	-	(33)
Exchange differences	(942)	-	(942)	158	-	158
Benefits paid	(1,264)	(169)	(1,433)	(1,357)	(146)	(1,503)
Ending balance	16,628	1,331	17,959	18,658	1,519	20,177

(ii) Movement in the fair value of plan assets:

	For the year ended December 31, 2021			For the year ended December 31, 2020		
	Non-US plans US\$'000	US SERP US\$'000	Total US\$'000	Non-US plans US\$'000	US SERP US\$'000	Total US\$'000
Opening balance	(1,724)	-	(1,724)	(1,650)	-	(1,650)
Interest income	(39)	-	(39)	(45)	-	(45)
Loss on plan assets, excluding amounts included in interest income	11	-	11	21	-	21
Administrative expenses	5	-	5	4	-	4
Employer contributions	(1,327)	(169)	(1,496)	(1,332)	(146)	(1,478)
Exchange differences	146	-	146	(79)	-	(79)
Benefits paid	1,264	169	1,433	1,357	146	1,503
Ending balance	(1,664)	-	(1,664)	(1,724)	-	(1,724)

Notes to the Consolidated Financial Statements

17 RETIREMENT BENEFITS AND COMPENSATION (Continued)**(a) Pension – defined benefit plans** (Continued)

Plan assets comprise as follows:

	As at December 31,	
	2021	2020
Equities	2%	2%
Bonds	2%	2%
Cash and cash equivalents	2%	2%
Other	94%	94%
	100%	100%

Amounts recognised in other comprehensive income:

	For the year ended December 31, 2021			For the year ended December 31, 2020		
	Non-US plans US\$'000	US SERP US\$'000	Total US\$'000	Non-US plans US\$'000	US SERP US\$'000	Total US\$'000
Gains (losses) from changes in financial assumptions	2,042	24	2,066	(1,908)	(56)	(1,964)
Experience (losses) gains	(156)	6	(150)	(309)	3	(306)
(Loss) gains from changes in demographic assumptions	(1)	–	(1)	33	–	33
Loss on plan assets, excluding amounts included in interest income	(11)	–	(11)	(21)	–	(21)
Total	1,874	30	1,904	(2,205)	(53)	(2,258)

Notes to the Consolidated Financial Statements

17 RETIREMENT BENEFITS AND COMPENSATION (Continued)**(a) Pension – defined benefit plans** (Continued)

Amount recognised in the Consolidated Financial Statements:

	For the year ended December 31, 2021			For the year ended December 31, 2020		
	Non-US plans US\$'000	US SERP US\$'000	Total US\$'000	Non-US plans US\$'000	US SERP US\$'000	Total US\$'000
Current service cost	1,277	–	1,277	1,086	–	1,086
Past-service cost	–	–	–	(93)	–	(93)
Interest cost	745	11	756	615	33	648
Administrative expenses	5	–	5	4	–	4
Total	2,027	11	2,038	1,612	33	1,645
<i>Included in:</i>						
Cost of sales	1,425	–	1,425	990	–	990
Engineering and product development costs	381	–	381	399	–	399
Selling and distribution costs	186	–	186	48	–	48
Administrative expenses	35	11	46	175	33	208
	2,027	11	2,038	1,612	33	1,645

Principal actuarial assumptions used were as follows:

	December 31, 2021		December 31, 2020	
	Non-US plans	US SERP	Non-US plans	US SERP
Discount rate	5.61%	1.55%	4.56%	0.81%
Salary increase rate	4.57%	N/A	4.57%	N/A
Price inflation rate	3.16%	N/A	3.16%	N/A
Pension increase rate	1.75%	N/A	1.75%	N/A

Notes to the Consolidated Financial Statements

17 RETIREMENT BENEFITS AND COMPENSATION (Continued)**(a) Pension – defined benefit plans** (Continued)

Balances of pension obligations derived from changes in the discount rate and salary increase rate as at the respective year-ends were as follows:

	December 31, 2021			December 31, 2020		
	Non-US plans US\$'000	US SERP US\$'000	Total US\$'000	Non-US plans US\$'000	US SERP US\$'000	Total US\$'000
1% increase in discount rate	15,016	1,300	16,316	16,671	1,480	18,151
1% decrease in discount rate	18,559	1,365	19,924	20,981	1,561	22,542
1% increase in salary increase rate	17,766	N/A	17,766	19,960	N/A	19,960
1% decrease in salary increase rate	15,631	N/A	15,631	17,500	N/A	17,500

The above sensitivity analyses are based on a change in an assumption while holding all other assumptions constant. In practice, this is unlikely to occur and changes in some of the assumptions may be correlated. When calculating the sensitivity of the defined benefit obligation the same actuarial method has been applied in arriving at the pension liability recognised in the Consolidated Financial Statements.

(b) Extended disability benefits

Costs associated with extended disability benefits provided to injured employees in the US are accrued throughout the duration of active employment. Workforce demographic data and historical experience are utilised to develop projections of time frames and related expenses for these post-employment benefits.

(c) Workers' compensation

The Group is self-insured up to a certain amount of workers' compensation claims for hourly workforce and accrues estimated costs for filed claims based upon an actuarially determined estimate. Workers' compensation liability includes benefits related to medical, dental and vision benefits.

18 PROVISIONS

	As at December 31, 2021			As at December 31, 2020		
	Current US\$'000	Non- current US\$'000	Total US\$'000	Current US\$'000	Non- current US\$'000	Total US\$'000
Litigation ⁽ⁱ⁾	140	668	808	169	346	515
Environmental liabilities ⁽ⁱⁱ⁾	150	11,889	12,039	150	11,910	12,060
Warranties ⁽ⁱⁱⁱ⁾	17,098	38,677	55,775	18,378	38,196	56,574
Decommissioning ^(iv)	–	9,374	9,374	–	8,977	8,977
	17,388	60,608	77,996	18,697	59,429	78,126

Notes to the Consolidated Financial Statements

18 PROVISIONS (Continued)

Movement of provisions is as follows:

	Litigation⁽ⁱ⁾ US\$'000	Environmental liabilities⁽ⁱⁱ⁾ US\$'000	Warranties⁽ⁱⁱⁱ⁾ US\$'000	Decommissioning^(iv) US\$'000	Total US\$'000
As at January 1, 2020	833	12,128	62,271	8,841	84,073
Additions, net	202	(1)	10,745	88	11,034
Payments	(492)	(52)	(18,284)	(2)	(18,830)
Exchange differences	(28)	(15)	1,842	50	1,849
As at December 31, 2020	515	12,060	56,574	8,977	78,126
As at January 1, 2021	515	12,060	56,574	8,977	78,126
Additions, net	419	(1)	14,446	415	15,279
Payments	(109)	(16)	(14,840)	-	(14,965)
Exchange differences	(17)	(4)	(405)	(18)	(444)
As at December 31, 2021	808	12,039	55,775	9,374	77,996

Notes:

(i) Litigation

The balance represents a provision primarily for certain labour claims brought against the Group. Litigation is subject to many uncertainties and the outcome of the individual litigated matters is not predictable with assurance. Based on currently available information, it is the opinion of management that the outcome of such matters will not have a material adverse impact on the Group.

(ii) Environmental liabilities

A provision is recognised for remediation costs to be incurred for the restoration of the manufacturing sites upon the initial recognition of the related assets.

(iii) Warranty

A provision is recognised for warranty costs associated with products sold to the customer principally at the time of sale or when it is determined that such obligations are probable and can be reasonably estimated.

(iv) Decommissioning

This represents asset retirement obligations at certain of the Group's facilities.

Notes to the Consolidated Financial Statements

19 DEFERRED REVENUE

Contract liabilities are associated with consideration received from customers in advance of transferring goods promised in a contract. The Group periodically receives upfront consideration from customers in connection with engineering, prototyping and pre-production programme-specific activities. These revenue amounts are deferred and recognised over the life of the related programme, which typically ranges between four and seven years. The carrying amount of deferred revenue is as follows:

	As at December 31, 2021			As at December 31, 2020		
	Current US\$'000	Non- current US\$'000	Total US\$'000	Current US\$'000	Non- current US\$'000	Total US\$'000
Pre-production activity	23,691	86,737	110,428	21,645	69,071	90,716

Movement of deferred revenue is as follows:

	As at December 31,	
	2021 US\$'000	2020 US\$'000
As at January 1	90,716	104,317
Additions	38,982	19,900
Recognised in profit or loss	(19,345)	(33,835)
Exchange differences	75	334
As at December 31	110,428	90,716

20 TRADE PAYABLES

	As at December 31,	
	2021 US\$'000	2020 US\$'000
Trade payables	625,288	630,583
Notes payable	41,213	26,572
	666,501	657,155

Certain vendors in China are paid for goods and services through the use of notes payable. Included in trade payables are notes payable issued to suppliers outstanding in the amount of US\$41,213,000 as at December 31, 2021 (December 31, 2020: US\$26,572,000). As at December 31, 2021, notes payable totalling US\$9,398,000 (December 31, 2020: US\$9,235,000) were pledged by notes receivable in the same amount recorded within trade receivables as set out in note 11.

Notes to the Consolidated Financial Statements

20 TRADE PAYABLES (Continued)

The ageing analysis of trade payables based on invoice date is as follows:

	As at December 31,	
	2021	2020
	US\$'000	US\$'000
0 to 30 days	389,542	371,088
31 to 60 days	176,742	180,727
61 to 90 days	52,492	64,261
91 to 120 days	9,693	15,906
Over 120 days	38,032	25,173
	666,501	657,155

21 OTHER PAYABLES AND ACCRUALS

	As at December 31,	
	2021	2020
	US\$'000	US\$'000
Accrued expenses	119,938	129,997
Deposits from customers	2,007	2,248
Other taxes payable	11,046	10,953
Others	2,447	5,889
	135,438	149,087
Less: non-current portion	(15,030)	(16,982)
	120,408	132,105

22 OTHER GAINS (LOSSES), NET

	For the year ended December 31,	
	2021	2020
	US\$'000	US\$'000
Foreign exchange gains (losses), net	10,236	(6,349)
Loss on disposal of property, plant and equipment	(2,224)	(9,608)
Others	9,126	6,421
	17,138	(9,536)

Notes to the Consolidated Financial Statements

23 EXPENSE BY NATURE

	For the year ended December 31,	
	2021 US\$'000	2020 US\$'000
Inventories used, including finished goods and work-in-progress	2,106,884	1,815,292
Employee benefit costs (note 24)	489,739	455,422
Temporary labour costs	107,687	105,257
Supplies and tools	193,743	179,088
Depreciation on property, plant and equipment (note 6)	134,065	122,010
Depreciation on right-of-use assets (note 7)	13,394	13,208
Amortisation on intangible assets (note 8)	105,298	93,357
Impairment (reversals) charges on		
– trade receivables (note 11)	(370)	689
– intangible assets (note 8) ⁽ⁱ⁾	(7,209)	34,147
– property, plant and equipment (note 6)	–	(3,437)
(Reversal of write-down) write-down of inventories (note 10)	(2,403)	2,304
Warranty expenses (note 18)	14,446	10,745
Auditors' remuneration		
– audit services	1,785	2,256
– non-audit services	208	1,963
Others	103,381	71,646
Total cost of sales, engineering and product development costs, selling and distribution, and administrative expenses	3,260,648	2,903,947

Note:

- (i) The amount represents impairments of US\$1,465,000 (2020: US\$34,147,000) related to programme cancellations and declining volumes on specific customer programmes as set out in note 8. The amount for the year ended December 31, 2021 also included income received of US\$8,674,000 due to customer recovery for a previously cancelled customer programme.

24 EMPLOYEE BENEFIT COSTS

	For the year ended December 31,	
	2021 US\$'000	2020 US\$'000
Salary expenses ⁽ⁱ⁾	357,146	334,669
Pension costs – defined contribution plans	28,475	24,837
Pension costs – defined benefit plans (note 17)	2,038	1,645
Other employee costs ⁽ⁱ⁾	102,080	94,271
Total	489,739	455,422

Note:

- (i) Salary expenses in the amount of US\$22,755,000 have been reclassified from other employee benefit costs to salary expenses in 2020 to conform to the 2021 presentation.

Notes to the Consolidated Financial Statements

24 EMPLOYEE BENEFIT COSTS (Continued)**(a) Share-based payments**

Pursuant to a shareholders' resolution passed on June 5, 2014, the Company adopted a share option scheme (**the Scheme**). The Scheme will remain in force for a period of 10 years commencing from June 5, 2014 and the period within which the option may be exercised must expire no later than 10 years from the relevant date of grant.

The subscription price for the shares under the option to be granted will be determined by the Board of Directors and will be the higher of: (a) the closing price of the shares of the Company as stated in the daily quotations sheet issued by The Stock Exchange of Hong Kong Limited on the date of grant; (b) the average closing price of the shares of the Company as stated in the daily quotations sheet issued by The Stock Exchange of Hong Kong Limited for the five business days immediately preceding the date of grant; or (c) the nominal value of the shares of the Company. The valuation of share options involves the use of option pricing models that involve variables and assumptions that are subject to estimates and subjective assumptions.

The options will be vested and become exercisable after the grantees complete a period of service of 1 to 3 years from the date of grant and subject to the Group achieving its performance targets.

On June 11, 2014, the Board of Directors approved an initial grant of share options under the Scheme, pursuant to which options to subscribe for 11,236,860 shares, representing approximately 0.4499% of the issued share capital of the Company as at the date of grant, were granted to 15 selected participants at the exercise price of HK\$5.150 per share.

On June 10, 2015, the Board of Directors approved a second grant of share options under the Scheme, pursuant to which options to subscribe for 10,358,990 shares, representing approximately 0.415% of the issued share capital of the Company as at the date of grant, were granted to 13 selected participants at the exercise price of HK\$8.610 per share.

On June 10, 2016, the Board of Directors approved a third grant of share options under the Scheme, pursuant to which options to subscribe for 10,602,490 shares, representing approximately 0.424% of the issued share capital of the Company as at the date of grant, were granted to 13 selected participants at the exercise price of HK\$7.584 per share.

On May 29, 2017, the Board of Directors approved a fourth grant of share options under the Scheme, pursuant to which options to subscribe for 11,919,310 shares, representing approximately 0.476% of the issued share capital of the Company as at the date of grant, were granted to 13 selected participants at the exercise price of HK\$11.620 per share.

Notes to the Consolidated Financial Statements

24 EMPLOYEE BENEFIT COSTS (Continued)**(a) Share-based payments** (Continued)

On May 30, 2018, the Board of Directors approved a fifth grant of share options under the Scheme, pursuant to which options to subscribe for 12,972,770 shares, representing approximately 0.518% of the issued share capital of the Company as at the date of grant, were granted to 15 selected participants at the exercise price of HK\$12.456 per share.

On August 21, 2019, the Board of Directors approved a sixth grant of share options under the Scheme, pursuant to which options to subscribe for 13,675,070 shares, representing approximately 0.545% of the issued share capital of the Company as at the date of grant, were granted to 16 selected participants at the exercise price of HK\$6.390 per share.

Movements in the number of share options outstanding and their average exercise prices are as follows:

	Average exercise price (per share) HK\$	Outstanding options (thousands)
As at January 1, 2020	9.138	37,745
Expired	9.656	(14,261)
Forfeited	11.401	(1,346)
As at December 31, 2020	8.667	22,138
Exercisable as at December 31, 2020	9.033	12,501
As at January 1, 2021	8.667	22,138
Exercised	6.246	(2,279)
Expired	9.503	(5,576)
Forfeited	6.390	(1,346)
As at December 31, 2021	8.970	12,937
Exercisable as at December 31, 2021	9.655	10,222

Notes to the Consolidated Financial Statements

24 EMPLOYEE BENEFIT COSTS (Continued)**(a) Share-based payments** (Continued)

Share options outstanding and not yet exercisable at the end of the period have the following vesting dates and exercise prices:

	Average exercise price (per share) HK\$	Outstanding options (thousands)
August 20, 2022	6.390	2,715

There were no options granted during the years ended December 31, 2021 and December 31, 2020. As at December 31, 2021, there were 179,014,910 share options available under the Scheme (December 31, 2020: 179,014,910 share options).

The fair value of the share options charged to the Consolidated Financial Statements was US\$nil for the year ended December 31, 2021 (year ended December 31, 2020: US\$nil) as no shares vested during the year due to the performance conditions not being met.

(b) Directors' emoluments

The remuneration of each director for the year ended December 31, 2021 is set out below:

	Fees ^(ix) US\$'000	Salary US\$'000	Annual Incentive Compensation ⁽ⁱⁱ⁾ US\$'000	Other benefits ⁽ⁱⁱⁱ⁾ US\$'000
Mr. ZHAO, Guibin* ⁽ⁱ⁾	–	1,040	972	56
Mr. MILAVEC, Robin Zane ^{(i)(xiii)}	–	485	232	112
Mr. FAN, Yi ⁽ⁱ⁾	–	250	95	69
Mr. WEI, Kevin Cheng	68	–	–	–
Mr. LIU, Jianjun	56	–	–	–
Mr. YICK, Wing Fat Simon	68	–	–	–
Mr. LEI, Zili ^(x)	24	–	–	–
Mr. WANG, Jian	124	–	–	–
Ms. ZHANG, Wendong ^(xi)	42	–	–	–
Mr. LIU, Ping ^(xii)	18	–	–	–

Notes to the Consolidated Financial Statements

24 EMPLOYEE BENEFIT COSTS (Continued)**(b) Directors' emoluments** (Continued)

The remuneration of each director for the year ended December 31, 2020 is set out below:

	Fees ^(ix) US\$'000	Salary US\$'000	Annual Incentive Compensation ⁽ⁱⁱⁱ⁾ US\$'000	Other benefits ⁽ⁱⁱⁱ⁾ US\$'000
Mr. ZHAO, Guibin * ⁽ⁱ⁾	–	1,040	892	47
Mr. MILAVEC, Robin Zane ^{(i)(xiii)}	–	375	148	102
Mr. FAN, Yi ⁽ⁱ⁾	–	223	87	93
Mr. RICHARDSON, Michael Paul ^{(i)(xiv)}	–	2	–	34
Mr. WEI, Kevin Cheng	68	–	–	–
Mr. LIU, Jianjun	56	–	–	–
Mr. YICK, Wing Fat Simon	68	–	–	–
Mr. ZHANG, Jianxun	36	–	–	–
Mr. WANG, Jian	124	–	–	–
Ms. ZHANG, Wendong ^(xi)	6	–	–	–
Mr. LIU, Ping ^(xii)	42	–	–	–

* Chief Executive Officer of the Company

Notes:

- (i) Individual is a member of senior management.
- (ii) The annual incentive compensation plan is payable within one year from year-end.
- (iii) Other benefits include payments made for dental, disability and healthcare coverage; contributions to social security and health-saving accounts; and other non-monetary benefits.
- (iv) During the year ended December 31, 2021, no retirement benefits by a defined benefit pension plan operated by the Group were paid or made, directly or indirectly, to or receivable by a director in respect of their services as a director or other services in connection with the management of the affairs of the Company or its subsidiaries (2020: nil).
- (v) During the year ended December 31, 2021, no payments or benefits in respect of termination of director's services were paid or made, directly or indirectly, to or receivable by a director; nor are any payable (2020: nil).
- (vi) During the year ended December 31, 2021, no consideration was provided to or receivable by third parties for making available director's services (2020: nil).
- (vii) There are no loans, quasi-loans or other dealings in favour of the directors, their controlled bodies corporate and connected entities (2020: nil).
- (viii) No significant transactions, arrangements and contracts in relation to the Group's business to which the Company or any of its subsidiaries was a party and in which a director of the Company had a material interest, whether directly or indirectly, subsisted at the end of the year or at any time during the year (2020: nil).
- (ix) Fees paid are in respect to service as a director, other emoluments are in respect of other services in connection with management of the Company or its subsidiaries.
- (x) Mr. LEI, Zili was appointed as our non-Executive Director with effect from June 8, 2021.

Notes to the Consolidated Financial Statements

24 EMPLOYEE BENEFIT COSTS (Continued)**(b) Directors' emoluments** (Continued)

Notes: (Continued)

- (xi) Ms. ZHANG, Wendong was appointed as our non-Executive Director with effect from November 13, 2020.
- (xii) Mr. LIU, Ping retired as our non-Executive Director with effect from June 8, 2021.
- (xiii) Mr. MILAVEC, Robin Zane was appointed as our Executive Director with effect from June 30, 2020.
- (xiv) Mr. RICHARDSON, Michael Paul retired as our Executive Director with effect from January 1, 2020.
- (xv) Deferred incentive compensation plans will be settled when all the conditions are met and with approval by the Board of Directors (certain of which with estimates based upon the extent of meeting certain performance targets). During the year ended December 31, 2021, the deferred incentive compensation of Mr. ZHAO, Guibin; Mr. MILAVEC, Robin Zane; Mr. FAN, Yi; Mr. RICHARDSON, Michael Paul; Mr. WANG, Jian; Mr. LIU, Ping; and Ms. ZHANG, Wendong, measured according to IFRS, were approximately US\$4,277,000, US\$1,231,000, US\$397,000, US\$nil, US\$370,000, US\$nil, and US\$23,000 (2020: US\$1,441,000, US\$252,000, US\$148,000, US\$nil, US\$33,000, US\$16,000, and US\$16,000) respectively. The share-based payments of the share option scheme included in the deferred incentive compensation are calculated and disclosed in accordance with the method set out in note 24(a). These disclosed values deviate from the intrinsic value because the Company used the binomial model to calculate the fair value of the options granted on June 11, 2014, June 10, 2015, June 10, 2016, May 29, 2017, May 30, 2018 and August 21, 2019 amounting to HK\$2.710, HK\$3.920, HK\$3.320, HK\$4.440, HK\$4.450 and HK\$2.590 per option, respectively. When the actual share price is lower than the exercise price of HK\$5.150, HK\$8.610, HK\$7.584, HK\$11.620, HK\$12.456 and HK\$6.390 per share for options granted on June 11, 2014, June 10, 2015, June 10, 2016, May 29, 2017, May 30, 2018 and August 21, 2019, respectively the options are out-of-money and the holders will not be benefitted by exercising the options.

(c) Five highest paid individuals

The five individuals whose emoluments were the highest in the Group for the year ended December 31, 2021 include two directors (2020: one), whose emoluments are reflected in the analysis presented above. The emoluments payable to the remaining three (2020: four) individuals during the year are as follows:

	For the year ended	
	December 31, 2021	2020
	US\$'000	US\$'000
Salaries and allowances	2,302	1,775
Annual and deferred incentive compensation	1,499	2,520
Other benefits	423	510
	4,224	4,805

Notes to the Consolidated Financial Statements

24 EMPLOYEE BENEFIT COSTS (Continued)**(c) Five highest paid individuals** (Continued)

The emoluments of the remaining individuals fell within the following bands:

	For the year ended December	
	2021	2020
	Number of individuals	
HK\$6,500,000 – HK\$7,000,000 (US\$834,000 – US\$898,000)	–	1
HK\$7,000,000 – HK\$7,500,000 (US\$898,000 – US\$962,000)	–	1
HK\$8,500,000 – HK\$9,000,000 (US\$1,090,000 – US\$1,154,000)	1	–
HK\$9,000,000 – HK\$9,500,000 (US\$1,154,000 – US\$1,218,000)	–	1
HK\$10,500,000 – HK\$11,000,000 (US\$1,347,000 – US\$1,411,000)	1	–
HK\$13,000,000 – HK\$13,500,000 (US\$1,667,000 – US\$1,731,000)	1	–
HK\$13,500,000 – HK\$14,000,000 (US\$1,731,000 – US\$1,795,000)	–	1

During the years ended December 31, 2021 and 2020, no emoluments were paid by the Group to the five highest paid individuals as an inducement to join or upon joining the Group or as compensation for loss of office.

(d) Performance awards

Pursuant to an award agreement granted on November 13, 2020, the Company granted 16,299,000 units of performance awards to certain eligible individuals determined by the Board of Directors (**2020 Performance Awards**). The 2020 Performance Awards will remain in force for a period beginning on November 13, 2020 and ending on June 30, 2023. 2020 Performance awards will be equally vested in three tranches in 2021, 2022 and 2023 under the circumstance that non-market performance conditions are met. Each unit of performance awards will be settled in cash for appreciation amounts between the stock price of the Company on the end date of the tranche and the initial stock price of HK\$4.36 determined by the Board of Directors (**Initial Stock Price**).

As at December 31, 2021, the weighted average fair value of outstanding tranches of unit awards granted during November 2020 were determined using a Black-Scholes model of HK\$5.491 per unit. The outstanding tranches of unit performance awards have an average maximum cash payout not to exceed HK\$5.491 per unit (HK\$9.851 per unit less initial stock price at grant date of HK\$4.360) or US\$2,918,000 per tranche. The significant inputs into the model were initial stock price at grant date of HK\$4.360, the 30-day average stock price immediately before December 31, 2021 of HK\$9.972, weighted average volatility of 68.86%, an expected term ranging between 0.5 and 1.5 years, and an annual risk-free interest rate ranging between 0.19% and 0.56%. For the year ended December 31, 2021, the fair value of the performance awards of US\$4,875,000 was charged to the Consolidated Financial Statements (year ended December 31, 2020: US\$1,116,000). For the year ended December 31, 2021, 2,457,530 units of 2020 Performance Awards were forfeited, and 5,202,000 units of 2020 Performance Awards totaling US\$2,974,000 were settled in cash upon vesting. As at December 31, 2021, the payable for performance awards of US\$3,017,000 was included in 'other payables and accruals' (December 31, 2020: US\$1,116,000).

Notes to the Consolidated Financial Statements

24 EMPLOYEE BENEFIT COSTS (Continued)**(d) Performance awards** (Continued)

Pursuant to an award agreement granted on June 1, 2021, the Company granted 18,055,000 units of performance awards to certain eligible individuals determined by the Board of Directors (**2021 Performance Awards**). The 2021 Performance Awards will remain in force for a period beginning on June 1, 2021 and ending on June 30, 2024. 2021 Performance Awards will be equally vested in three tranches in 2022, 2023 and 2024 under the circumstance that non-market performance conditions are met. Each unit of 2021 Performance Awards will be settled in cash for appreciation amounts between the stock price of the Company on the end date of the tranche and the initial stock price of HK\$10.18 determined by the Board of Directors.

As at December 31, 2021, the weighted average fair value of outstanding tranches of unit awards granted in June 2021 were determined using a Black-Scholes model of HK\$2.942 per unit. The outstanding tranches of 2021 Performance Awards have an average maximum cash payout not to exceed HK\$5.346 per unit (HK\$15.526 per unit less initial stock price at grant date of HK\$10.180) or US\$3,404,000 per tranche. The significant inputs into the model were initial stock price at grant date of HK\$10.180, the 30-day average stock price immediately before December 31, 2021 of HK\$9.972, weighted average volatility of 66.70%, an expected term ranging between 0.5 and 2.5 years, and an annual risk-free interest rate ranging between 0.19% and 0.85%. For the year ended December 31, 2021, the fair value of the 2021 Performance Awards of US\$1,634,000 was charged to the Consolidated Financial Statements (year ended December 31, 2020: US\$nil). For the year ended December 31, 2021, 3,160,380 units of 2021 Performance Awards were forfeited. As at December 31, 2021 the payable for the 2021 Performance Awards of US\$1,634,000 (December 31, 2020: US\$nil) was included in 'other payables and accruals'.

Notes to the Consolidated Financial Statements

25 FINANCE INCOME/FINANCE COSTS

	For the year ended December 31,	
	2021 US\$'000	2020 US\$'000
Finance income		
Interest on bank deposits	4,426	4,096
Finance costs		
Interest on bank borrowings	6,090	4,157
Interest on notes	3,753	14,687
	9,843	18,844
Interest on leases	3,201	3,574
Other finance costs	2,956	3,299
	16,000	25,717
Less: amount capitalised in qualifying assets (notes 6 and 8)	(9,719)	(16,561)
	6,281	9,156
	1,855	5,060

26 INCOME TAX BENEFIT

	For the year ended December 31,	
	2021 US\$'000	2020 US\$'000
Current income tax expense	(23,770)	(3,073)
Deferred income tax benefit (note 9)	36,160	10,914
	12,390	7,841

The Coronavirus Aid, Relief, and Economic Security (**CARES**) Act was passed by the US Congress and signed into law on March 27, 2020. The CARES Act provided for a carryback of any NOL arising in a taxable year beginning after December 31, 2017 and before January 1, 2021, to each of the five taxable years preceding the taxable year in which the loss arises (**Carryback Period**). As a result of this provision, taxpayers take into account such NOLs in the earliest taxable year in the Carryback Period, carrying forward unused amounts to each succeeding taxable year. The Group has applied this provision to its tax calculation for the 2020 US tax NOL for the year ended December 31, 2021 and recognised a benefit of US\$6,832,000 for the NOL carryback (2020: US\$9,809,000).

Taxation on the Group's profits has been calculated on the estimated assessable profits for both years at the statutory rates of 21%, 25% and 19% in US, China and Poland, respectively, from where the Group's profits were mainly generated.

Notes to the Consolidated Financial Statements

26 INCOME TAX BENEFIT (Continued)

The tax on the Group's profit before tax differs from the theoretical amount that would arise from tax calculated at rates applicable to profits in respective countries of the combined entities as follows:

	For the year ended December 31,	
	2021 US\$'000	2020 US\$'000
Profit before income tax	114,013	114,462
Tax calculated at rates applicable to profits in respective countries	(29,924)	(28,274)
Expenses not deductible for tax purposes	(484)	(299)
Non-taxable income	10,863	12,462
Tax credits ⁽ⁱ⁾	13,713	12,126
Preferential rates and tax holidays ⁽ⁱⁱ⁾	13,359	8,790
Tax losses and deductible temporary differences for which no deferred tax was recognised	(209)	(4,261)
Rate benefit on US net operating loss ⁽ⁱⁱⁱ⁾	6,832	9,809
US state and withholding taxes ^(iv)	(6,899)	(2,573)
Others	5,139	61
Income tax benefit	12,390	7,841

Notes:

- (i) Mainly represents research and royalty incentives.
- (ii) Derived mainly from profits subject to preferential tax rate in China for high-technology enterprises. Also includes tax exemption through 2026 for the Group's investment in Special Economic Zones in Poland according to the relevant Polish tax rules.
- (iii) The US CARES Act NOL carryback provided a permanent tax rate benefit.
- (iv) Includes withholding taxes on intercompany dividends anticipated to be paid in the foreseeable future.

27 EARNINGS PER SHARE**(a) Basic**

Basic earnings per share is calculated by dividing the profit attributable to equity holders of the Company by the weighted average number of ordinary shares in issue during the year.

	For the year ended December 31,	
	2021	2020
Profit attributable to the equity holders of the Company (US\$'000)	118,440	116,766
Weighted average number of ordinary shares in issue (thousands)	2,509,004	2,507,545
Basic earnings per share (in US\$)	0.05	0.05

Notes to the Consolidated Financial Statements

27 EARNINGS PER SHARE (Continued)**(b) Diluted**

Diluted earnings per share is calculated by adjusting the weighted average number of ordinary shares outstanding to assume conversion of all dilutive potential ordinary shares. The Company's dilutive potential ordinary shares comprise of shares issued under the Scheme that are vested as at December 31, 2021. The number of shares that would have been issued assuming the exercise of the share options less the number of shares that could have been issued at fair value (determined as the average market price per share for the year ended December 31, 2021) for the same total proceeds is the number of shares issued for no consideration. The resulting number of shares issued for no consideration is included in the weighted average number of ordinary shares within the denominator for calculating diluted earnings per share. For the years ended December 31, 2021 and 2020, the details are within the table below.

	For the year ended December 31,	
	2021	2020
Profit attributable to equity holders of the Company, used to determine diluted earnings per share (US\$'000)	118,440	116,766
Weighted average number of ordinary shares in issue (thousands)	2,509,004	2,507,545
Adjustment for share options (thousands)	2,527	285
Weighted average number of ordinary shares in issue for calculating diluted earnings per share (thousands)	2,511,531	2,507,830
Diluted earnings per share (in US\$)	0.05	0.05

28 DIVIDENDS

	For the year ended December 31,	
	2021	2020
	US\$'000	US\$'000
Dividend proposed of US\$0.0095 (2020: US\$0.0094) per share	23,843	23,571

This 2021 dividend was proposed by the directors at a meeting held on March 16, 2022, the date of approval of these Consolidated Financial Statements, which is not reflected as a dividend payable in these Consolidated Financial Statements.

Notes to the Consolidated Financial Statements

29 CONSOLIDATED STATEMENTS OF CASH FLOWS**(a) Cash generated from operations**

	For the year ended December 31,	
	2021 US\$'000	2020 US\$'000
Profit before income tax	114,013	114,462
Adjustments for:		
Finance costs	6,281	9,156
Depreciation on property, plant and equipment	134,065	122,010
Reversals of impairment charges of property, plant and equipment	–	(3,437)
Depreciation on right-of-use assets	13,394	13,208
Amortisation on intangible assets	105,298	93,357
Impairment charges on intangible assets	1,465	34,147
Recognition of deferred revenue	(19,345)	(33,835)
Impairment (reversals) charges on trade and other receivables	(370)	689
(Reversals of write-down) write-down on inventories	(2,057)	1,718
Share of results of joint ventures	(653)	(795)
Share-based compensation	6,623	1,116
Loss on disposal of property, plant and equipment	2,224	9,608
	360,938	361,404
Changes in working capital:		
Increase in trade receivables and other receivables and prepayments	(32,109)	(39,708)
(Increase) decrease in inventories	(56,192)	34,952
Increase in payables and accruals	7,145	80,469
Decrease in provisions	(103)	(7,929)
Increase (decrease) in retirement benefits and compensations	236	(569)
Increase in deferred revenue	38,982	19,900
Cash generated from operations	318,897	448,519

Major non-cash transactions

During the year ended December 31, 2021, the Group purchased property, plant and equipment, which were recorded in payables in the amounts of US\$26,654,000 (2020: US\$36,671,000).

During the year ended December 31, 2021, the Group settled trade payables to suppliers with notes received from customers to settle trade receivables in the amount of US\$37,596,000 (2020: US\$40,029,000). These transactions were specific to China.

During the year ended December 31, 2021, the Group had non-cash additions to ROU assets and lease liabilities in the amount of US\$21,357,000 (2020: US\$7,611,000).

Notes to the Consolidated Financial Statements

29 CONSOLIDATED STATEMENTS OF CASH FLOWS (Continued)**(b) Net borrowings reconciliation**

(i) Movements in net borrowings for the year ended December 31, 2021 are as follows:

	Borrowings due within a year US\$'000	Borrowings due after a year US\$'000	Total US\$'000
As at January 1, 2020	58,825	248,829	307,654
Cash flows	(60,162)	–	(60,162)
Foreign exchange adjustments	12	–	12
Other non-cash movements	249,961	(248,829)	1,132
As at December 31, 2020	248,636	–	248,636
Cash flows	(164,498)	–	(164,498)
Foreign exchange adjustments	265	–	265
As at December 31, 2021	84,403	–	84,403

(ii) Movements in net lease liabilities for the year ended December 31, 2021 are as follows:

	Lease liabilities due within a year US\$'000	Lease liabilities due after a year US\$'000	Total US\$'000
As at January 1, 2020	12,291	49,381	61,672
Cash flows	(13,672)	–	(13,672)
Foreign exchange adjustments	417	1,604	2,021
Other non-cash movements	14,491	(7,158)	7,333
As at December 31, 2020	13,527	43,827	57,354
Cash flows	(13,709)	–	(13,709)
Foreign exchange adjustments	(269)	(923)	(1,192)
Other non-cash movements	12,841	7,068	19,909
As at December 31, 2021	12,390	49,972	62,362

30 COMMITMENTS**Capital commitments**

The Group has capital commitments of US\$138,185,000 as at December 31, 2021 to purchase property, plant and equipment which are contracted but not provided for (December 31, 2020: US\$133,026,000).

Notes to the Consolidated Financial Statements

31 RELATED PARTY TRANSACTIONS**(a) Transactions with Yubei Steering Systems Co., Ltd. (Yubei Steering) and Xingxiang Addway Automotive Technology Co., Ltd. (Addway), associates of AVIC**

	For the year ended December 31,	
	2021 US\$'000	2020 US\$'000
Purchase of goods	2,500	158

(b) Transactions with joint ventures

The following table sets forth the transactions between the Group and its joint ventures.

	For the year ended December 31,	
	2021 US\$'000	2020 US\$'000
Sale of product, equipment and services ⁽ⁱ⁾	68,664	68,550
Purchase of services ⁽ⁱ⁾	10,696	6,906

Note:

(i) Services include engineering services, rent, other fees.

Information about the Group's joint ventures is disclosed as follows:

Nexteer (China) Holding Co., Ltd. (**Nexteer China Holding**) (a direct, wholly-owned subsidiary of the Company) holds a 50% ownership interest in a joint venture, Chongqing Nexteer Steering Systems Co., Ltd. (**Chongqing Nexteer**) in Chongqing, China. The joint venture was formed to manufacture and sell steering parts and the remaining 50% interest is held by Chongqing Jianshe Industry (Group) Co., Ltd.

In March 2017, Nexteer China Holding signed a joint venture agreement with Dongfeng Motor Parts and Components (Group) Co., Ltd. to form Dongfeng Nexteer Steering Systems (Wuhan) Co., Ltd. (**Dongfeng Nexteer**). Located in Wuhan, China, the joint venture, equally owned by both parties, was formed to design and manufacture EPS systems for Dongfeng Motor Group Co., Ltd. and its affiliated companies. Production began during 2019, but the joint venture has not yet commenced significant customer production.

In January 2017, Nexteer Automotive Corporation (an indirect, wholly-owned subsidiary of the Company) agreed to form a joint venture with Continental Automotive Systems, Inc. Located in Grand Blanc, US, the joint venture, CNXMotion, LLC (**CNXMotion**), is focused on integrating lateral and longitudinal control for mixed mode and automated driving applications.

As at December 31, 2021 the Group's carrying amount of its investments in joint ventures is US\$22,904,000 including US\$15,652,000, US\$7,252,000 and US\$nil related to Chongqing Nexteer, Dongfeng Nexteer and CNXMotion, respectively, (December 31, 2020: US\$15,058,000, US\$7,224,000, US\$nil). For the year ended December 31, 2021, the Group's share of results of its joint ventures amount to US\$653,000, including US\$3,691,000, US\$29,000, and (US\$3,067,000) related to Chongqing Nexteer, Dongfeng Nexteer and CNXMotion, respectively, (year ended December 31, 2020: US\$3,073,000, (US\$298,000), (US\$1,980,000)). For the year ended December 31, 2021, the Group received a dividend from Chongqing Nexteer in the amount of US\$3,097,000 (2020: US\$nil).

Notes to the Consolidated Financial Statements

31 RELATED PARTY TRANSACTIONS (Continued)**(c) Key management compensation**

The remunerations of the CEO, directors and other key management members were as follows:

	For the year ended December 31,	
	2021 US\$'000	2020 US\$'000
Short-term employee benefits	13,084	10,395
Other long-term benefits	2,232	2,865
Termination benefits	1,100	–
Share-based payments	7,269	762
	23,685	14,022

These remunerations are determined based on the performance of individuals and market trends.

Notes to the Consolidated Financial Statements

32 BALANCE SHEET OF THE COMPANY

The balance sheet of the Company on a non-consolidated basis is as follows:

	As at December 31,	
	2021	2020
	US\$'000	US\$'000
ASSETS		
Non-current assets		
Investments in subsidiaries	845,309	845,288
Right-of-use assets	114	153
Other receivables and prepayments	21,236	21,288
	866,659	866,729
Current assets		
Other receivables and prepayments	1,873	19
Cash and cash equivalents	57	50
	1,930	69
Total assets	868,589	866,798
EQUITY		
Capital and reserves		
Share capital	32,377	32,347
Other reserves	456,431	455,651
Retained earnings (accumulated losses)	23,143	(15,242)
Total equity	511,951	472,756
Non-current liabilities		
Lease liabilities	75	115
Deferred income tax liabilities	9,850	7,250
	9,925	7,365
Current liabilities		
Borrowings	344,209	384,276
Lease liabilities	39	38
Other payables and accruals	2,465	2,363
	346,713	386,677
Total equity and liabilities	868,589	866,798

The balance sheet of the Company was approved by the Board of Directors on March 16, 2022 and was signed on its behalf.

ZHAO, Guibin

Director

FAN, Yi

Director

Notes to the Consolidated Financial Statements

32 BALANCE SHEET OF THE COMPANY (Continued)

The movement in reserves of the Company on a non-consolidated basis is as follows:

	Share premium US\$'000	Share-based compensation reserve US\$'000	Capital reserve US\$'000	Retained earnings (accumulated losses) US\$'000	Total reserves US\$'000
As at January 1, 2020	–	6,916	504,400	21,305	532,621
Loss for the year	–	–	–	(10,724)	(10,724)
Value of employee services provided under share-option scheme (note 24(a))	–	7	–	–	7
Dividends paid to shareholders	–	–	(55,672)	(25,823)	(81,495)
Exercise of share options	–	–	–	–	–
As at December 31, 2020	–	6,923	448,728	(15,242)	440,409
Profit for the year	–	–	–	60,921	60,921
Value of employee services provided under share-option scheme (note 24(a))	–	21	–	–	21
Transfer to share premium under exercise of share options	883	(883)	–	–	–
Exercise of share options	1,804	–	–	–	1,804
Dividends paid to shareholders	(1,045)	–	–	(22,536)	(23,581)
As at December 31, 2021	1,642	6,061	448,728	23,143	479,574

Notes to the Consolidated Financial Statements

33 SHARE CAPITAL

	Number of ordinary shares	Amount
<i>Issued and fully paid:</i>		
HK\$0.10 each as at January 1, 2020	2,507,544,833	HK\$250,754,483
HK\$0.10 each as at December 31, 2020	2,507,544,833	HK\$250,754,483
Exercise of share options	2,279,460	HK\$227,946
HK\$0.10 each as at December 31, 2021	2,509,824,293	HK\$250,982,429

Notes to the Consolidated Financial Statements

34 PARTICULARS OF PRINCIPAL SUBSIDIARIES AND JOINT VENTURES

	Place of operation, incorporation and date of incorporation	Issued and paid up capital	Attributable equity interest	Principal activities
Subsidiaries				
<i>Directly held:</i>				
Nexteer (China) Holding Co., Ltd. ⁽ⁱ⁾	China June 16, 2014	US\$30,000,000	100%	Investment holding
Nexteer UK Holding Ltd.	United Kingdom February 5, 2015	US\$161,120,152	100%	Investment holding
PCM (Singapore) Steering Holding Pte. Limited	Singapore November 4, 2010	US\$197,600,000 and SGD 1	100%	Investment holding
<i>Indirectly held:</i>				
Nexteer Automotive (Suzhou) Co., Ltd. ⁽ⁱ⁾	China January 24, 2007	US\$32,800,000	100%	Manufacturing of steering components, regional technical centre
Nexteer Automotive Australia Pty Ltd.	Australia January 23, 2008	AUD\$2,849,108	100%	Customer service centre
Nexteer Automotive Corporation	Delaware, US January 2, 2008	US\$1	100%	Manufacturing of steering and driveline components, global technical centre
Nexteer Automotive France SAS	France March 25, 2008	EUR1,287,000	100%	Customer service centre, engineering centre
Nexteer Automotive Germany GmbH	Germany January 2, 2008	EUR25,000	100%	Customer service centre, engineering centre
Nexteer Automotive India Private Limited	India February 25, 2008	INR207,917,940	100%	Manufacturing of steering and driveline components, software service centre
Nexteer Automotive Italy S.r.l.	Italy January 30, 2008	EUR10,000	100%	Customer support, engineering centre
Nexteer Automotive Japan LLC	Japan February 21, 2008	JPY1	100%	Customer support, engineering centre
Nexteer Automotive Korea Limited	Korea February 28, 2008	KRW 3,400,000,000	100%	Customer support, engineering centre

Notes to the Consolidated Financial Statements

34 PARTICULARS OF PRINCIPAL SUBSIDIARIES AND JOINT VENTURES (Continued)

	Place of operation, incorporation and date of incorporation	Issued and paid up capital	Attributable equity interest	Principal activities
Nexteer Automotive Luxembourg S.à r.l.	Luxembourg November 5, 2013	US\$20,000	100%	Investment holding
Nexteer Automotive Mexico S.de R.L. de C.V.	Mexico June 10, 2014	MXN129,912	100%	Distribution company
Nexteer Automotive Morocco S.à r.l.	Morocco October 12, 2017	EUR34,653,600	100%	Manufacturing of steering and driveline components
Nexteer Automotive Poland sp. z o.o.	Poland January 2, 1997	PLN20,923,750	100%	Manufacturing of steering components, regional technical centre
Nexteer Automotive Systems (Liuzhou) Co., Ltd. ⁽ⁱ⁾	China January 8, 2015	US\$10,000,000	100%	Manufacturing of steering components
Nexteer Cayman Finance Limited	Cayman Islands October 21, 2019	US\$2	100%	Intragroup financing
Nexteer Hungary Finance Kft.	Hungary March 5, 2019	US\$12,000	100%	Intragroup financing
Nexteer Hungary Investment Kft.	Hungary February 24, 2020	US\$13,000	100%	Intragroup financing
Nexteer Industria e Comercio de Sistemas Automotivos Ltda.	Brazil February 22, 2007	BRL311,423,316	100%	Manufacturing of steering and driveline components
Nexteer Lingyun Driveline (Wuhu) Co., Ltd. ⁽ⁱ⁾	China December 22, 2006	US\$22,400,000	60%	Manufacturing of driveline components
Nexteer Lingyun Driveline (Zhuozhou) Co., Ltd. ⁽ⁱ⁾	China October 6, 1995	US\$22,000,000	60%	Manufacturing of driveline components
Nexteer Luxembourg Holding VI S.à r.l. (formerly Rhodes I LLC)	Luxembourg (previously Michigan, US) November 7, 2007	EUR85,000	100%	Investment holding
Nexteer Luxembourg Holding VII S.à r.l. (formerly Rhodes II LLC)	Luxembourg (previously Michigan, US) November 7, 2007	EUR85,000	100%	Investment holding
Nexteer Otomotiv Sanayi ve Ticaret Limited Sirketi	Turkey March 28, 2008	TRY1,105,000	100%	Manufacturing of steering components

Notes to the Consolidated Financial Statements

34 PARTICULARS OF PRINCIPAL SUBSIDIARIES AND JOINT VENTURES (Continued)

	Place of operation, incorporation and date of incorporation	Issued and paid up capital	Attributable equity interest	Principal activities
Nexteer US Holding I LLC	Delaware, US May 18, 2007	–	100%	Investment holding
PCM US Steering Holding LLC	Delaware, US March 9, 2009	–	100%	Investment holding
PT Nexteer Automotive Indonesia	Indonesia March 23, 2016	US\$1,600,000	100%	Manufacturing of steering components
Rhodes Holding I S.à r.l.	Luxembourg January 15, 2008	EUR4,500,000	100%	Investment holding
Rhodes Holding II S.à r.l.	Luxembourg January 15, 2008	EUR4,331,151	100%	Investment holding
Steering Holding Pte. Ltd.	Singapore February 15, 2008	US\$6,400,000 and EUR1	100%	Engineering centre, investment holding
Steering Solutions Corporation	Delaware, US October 29, 2007	US\$1	100%	Investment holding
Steering Solutions Expat Holding Corporation	Delaware, US January 2, 2008	US\$1	100%	Employee support services
Steering Solutions IP Holding Corporation	Delaware, US January 2, 2008	US\$1	100%	Intellectual property management
Steeringmex S. de R.L. de C.V.	Mexico December 14, 2007	MXN100,292,971	100%	Manufacturing of steering and driveline components
<i>Joint ventures:</i>				
Chongqing Nexteer Steering Systems Co., Ltd. ⁽ⁱ⁾	China January 22, 2014	RMB120,000,000	50%	Manufacturing of steering components
CNXMotion, LLC	Delaware, US July 18, 2017	–	50%	Research and development centre
Dongfeng Nexteer Steering Systems (Wuhan) Co., Ltd. ⁽ⁱ⁾	China October 23, 2017	RMB150,000,000	50%	Manufacturing of steering components

(i) Foreign-invested enterprise registered under PRC law.

Five Years' Financial Summary

	For the year ended December 31,				
	2021 US\$'000	2020 US\$'000	2019 US\$'000	2018 US\$'000	2017 US\$'000
RESULTS					
Revenue	3,358,725	3,032,210	3,575,657	3,912,170	3,878,009
Profit before income tax	114,013	114,462	263,933	410,391	405,049
Income tax benefit (expense)	12,390	7,841	(29,275)	(26,045)	(49,171)
Profit for the year	126,403	122,303	234,658	384,346	355,878
Profit attributable to:					
Equity holders of the Company	118,440	116,766	232,445	379,657	351,769
Non-controlling interests	7,963	5,537	2,213	4,689	4,109
	126,403	122,303	234,658	384,346	355,878
Earnings per share, (US\$ per share)					
Basic and diluted	0.05	0.05	0.09	0.15	0.14
ASSETS AND LIABILITIES					
Total assets	3,206,499	3,305,741	3,258,972	3,111,511	2,979,383
Total liabilities	1,203,910	1,384,756	1,407,316	1,401,667	1,538,668
Total equity	2,002,589	1,920,985	1,851,656	1,709,844	1,440,715
Capital and reserves attributable to equity holders of the Company	1,954,629	1,882,002	1,811,981	1,671,810	1,402,411
Non-controlling interests	47,960	38,983	39,675	38,034	38,304
	2,002,589	1,920,985	1,851,656	1,709,844	1,440,715